



# Model 204 & 239 Operating Instructions

# Table of Contents

1.0 General information and installation .....	3
1.1 Ambient conditions .....	3
1.2 Installation of pressure fittings .....	3
2.0 Electrical information for standard 24 VDC excitation pressure transducers .....	5
2.1 Electrical .....	5
3.0 Electrical information for optional $\pm 15\text{VDC}$ and $\pm 24\text{VDC}$ .....	6
3.1 Electrical .....	6
3.2 Grounding .....	6
3.3 Power supply advice .....	6
4.0 Adjustments for zero and sensitivity .....	7
4.1 Zero pressure output.....	7
4.2 Sensitivity (span).....	7
4.3 Linearity .....	7
5.0 Remote control instructions for pressure transducers.....	8
6.0 Installation instructions for multiple hook-up of 4-wire .....	9
7.0 Returning products for repair .....	11
8.0 Limited warranty .....	11

# 1.0 General information and installation

Your Setra transducer has been carefully calibrated before shipment to you, and it should be handled with the same care given any precision instrument. Pressure range and dimensions are reported on the applicable specifications bulletin.

## 1.1 Ambient conditions

Do not submerge in liquids, use in ambient conditions corrosive to anodized aluminum, subject to spray or dripping, or use in a high vibration environment. The transducer is very slightly sensitive to acceleration in the pressure fitting axis (see applicable specifications bulletin for acceleration response specifications). Installation is recommended in the vertical position, with the pressure port downward. This position minimizes damage from drippage of pressure system piping.

## 1.2 Installation of pressure fittings

Your transducer is designed for most accurate operation when subjected to pressures within the designated pressure range. Refer to the catalog bulletin specifications for proof pressure limits. Subjection to excessive pressure voids the warranty. DO NOT OVERPRESSURE.

Standard sealants such as Teflon pipe tape generally are satisfactory. For the most sensitive pressure ranges, excessive high torquing of a metal pressure fitting may cause slight zero shift which may be trimmed out using the zero adjustment. Use of a plastic fitting often shows no noticeable zero shift. The torquing effect does not appreciably affect linearity or sensitivity. The wrench flat on the 204 and 239 series should be used when installing the positive pressure fitting.

## A. Positive pressure fitting and media compatibility

Model 204, 204D	1/4"-18 NPT internal fitting For use with gases or liquids compatible with 17-4 PH stainless steel. (316 stainless steel optional)
Model 239	1/8"-27 NPT internal fitting For use with gases compatible with stainless steel, hard anodized 6061 aluminum, Buna N "O" ring. (stainless steel in place of aluminum optional)

## B. Reference pressure fitting and media compatibility (differential pressure measurements only)

Model 204D	1/8"-27 NPT internal fitting For use with clean dry air, non- corrosive or non-conductive gases. Maximum line pressure 1000 PSIG.
------------	--

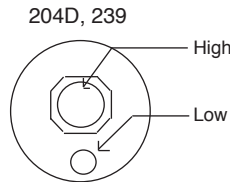

Model 239	1/8"-27 NPT internal fitting For use with non-corrosive, non-condensing clean dry air or other gases. Maximum line pressure 250 PSIG.
-----------	--

### Notes:

(1) Differential pressure Models can be used to measure gauge pressure by leaving the reference port open to atmosphere.

(2) Line Pressure refers to pressure applied to both high and low sides of the sensing device simultaneously. Refer to the product data sheet to determine maximum differential pressure and overpressure limits.

## 2.0 Electrical information for standard 24 VDC excitation pressure transducers (nominal)

### Connections (Model 204, 239; electrical termination Y1, Y4, Y4, Y6) Red Cable

Cable Lead	Function
White	Positive excitation
Yellow	Positive output
Brown	Negative output
Black	Negative excitation
Shield	Case

**Notes:** Other leads in the cable are not used with the standard pressure transducer unless the transducer has been wired for Remote Control (see Remote Control Instructions)

### Connections (Model 204, 239; electrical termination 02, 10, 25) Gray Cable

Cable Lead	Function
Red	Positive excitation
Black	Negative excitation
White	Negative output
Green	Positive output
Shield	Case

## 2.1 Electrical

The electrical circuit is equivalent to a 4 terminal network, which means negative excitation lead shall not be connected to negative signal output lead.

The pressure transducer must be operated with the case connected to earth ground to meet EMC requirement. Best performance will be achieved by connecting the shield and negative excitation lead if it is feasible and allowed.

The circuit has internal protection:

- Reversed excitation voltage for at least 5 minutes.
- Short-circuit or signal output leads.
- Short duration power line transients up to 150 volts.

### Note on long cable use

*In some instances, use of long cables (several hundred feet length) may introduce enough cable capacitance into the circuit to cause output oscillations. If encountered, this oscillation may be eliminated by connecting a 100 ohm resistor (1/8th watt or larger) in series to each of the output leads at the end of the 2 foot transducer cable. These series resistors, of course, add to the output resistance.*

### Atmospheric reference (Gauge pressure transducers only)

Lower range units are subject to excessive thermal zero shift unless vented to atmosphere. The electrical cable provides this equalization vent. Do not seal the electrical cable when installing.

# 3.0 Electrical information for optional $\pm 15$ VDC (option G) and $\pm 24$ VDC (option E)

## Excitation pressure transducers

**Note:** Any figures in parentheses ( ) pertain to the  $\pm 24$  VDC excitation units only.

### Connections (Model 204, 239; electrical termination Y1, Y3, Y4, Y6) Red cable (9 conductor)

Cable Lead	Function
White	+15 (+24) Positive excitation
Black (power supply)	Ground
Violet	-15 (-24) Negative excitation
Yellow	Positive output
Brown	Negative output
Shield	Case

**Notes:** Other leads in the cable are not used for electrical Option E and G unless the transducer has been wired for Remote Control (see Remote Instructions)

### 3.1 Electrical

Electrical G permits operation from a  $\pm 15$  VDC and electrical Option E permits operation from a  $\pm 24$  VDC supply (common return grounded), and provides you with the negative signal output lead also at the common ground potential. Thus many transducers can be operated from one power supply into single-ended loads. Circuit is reversed voltage protected for at least 5 minutes. Internal transient suppression network is provided for short duration transients to 150 volts.

### 3.2 Grounding

For general usage and best results (lowest noise) grounding of the shield/case to the black lead is recommended.

### 3.3 Power supply advice

This transducer has been designed to operate from a dual  $\pm 15$  VDC ( $\pm 24$  VDC ) source. Stated another way, the supply is a 30V (48V) center tapped supply. The  $\pm 15$  V ( $\pm 24$  V) is 15 V (24 V) above the common power return lead, and the - 15 V (- 24 V) is 15 V (24 V) below the common power return lead.

All three power leads must be connected. The transducer will not function if just the +15 V (+24 V) and -15 V (-24 V) leads are connected to the power source. To avoid circuit damage due to excessive voltage, the positive supply voltage should be held within the range of +15 V to +20 V (+22 V to +30 V), and the negative supply voltage should be held within the range of -10 V to -20 V (-10 V to -24 V).

**Note on long cable use:** In some instances, use of long cables (several hundred feet length) may introduce enough cable capacitance into the circuit to cause output oscillations. If encountered, this oscillation may be eliminated by connecting a 100 ohm resistor (1/8th watt or larger) in series to each of the output leads at the end of the 2 foot transducer cable. These series resistors, of course, add to the output resistance.

## 4.0 Adjustments for zero and sensitivity

### Adjustments for voltage output pressure transducers (cover must be removed)

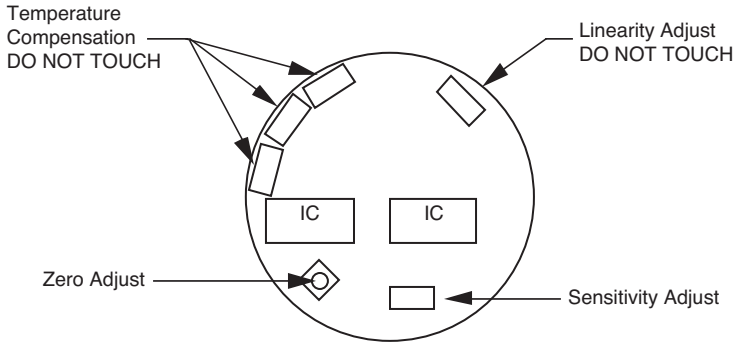

### CAUTION

TURN OFF EXCITATION POWER DURING COVER REMOVAL OR REPLACEMENT

#### 4.1 Zero pressure output

Can be adjusted to zero by potentiometer as shown in diagram. Unit factory - adjusted to zero output ( $\pm 10$  mV for Model 204 and  $\pm 20$  mV for Model 239).

#### 4.2 Sensitivity (span)

Can be adjusted by potentiometer as shown on outline diagram. Unit factory - adjusted to order specifications.

#### 4.3 Linearity

DO NOT TOUCH - Factory adjusted for best linearity. Touching any adjustments other than zero output or sensitivity may necessitate recalibration.

**Note:** Sensitivity (span) adjustment is not recommended unless a primary pressure standard (dead weight tester, etc.) is available for use as a reference.

# 5.0 Remote control instructions for pressure transducer

Cable leads indicated below are connected into the transducer circuitry on this transducer as ordered.

Connection of the remote control leads extends the internal zero and sensitivity adjustments. The transducer was factory calibrated with the remote control wiring disconnected.

### CAUTION

The remote control leads directly access active circuit elements. Inadvertent short-circuiting to each other, to ground, or other mis-wiring may cause immediate circuit damage. Keep remote control wiring either free of other contact or else keep the leads properly wired as shown below.

**Note:** All resistance elements are 0.1 watt or greater. All remote circuits have voltages less than 10 volts and currents less than 1 mA.

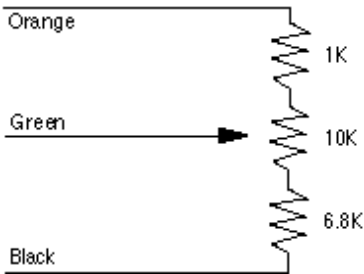

#### Remote zero adjustment (standard, red 9 conductor cable)

The transducer has been preset with the regular internal zero adjustment potentiometer. If remote zero control is desired, connect the orange, green and black leads as shown with external resistors and potentiometers.

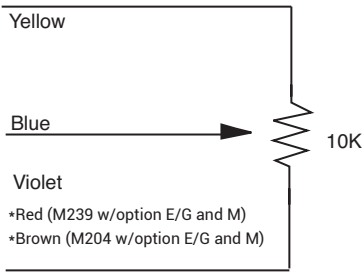

#### Remote sensitivity adjustment (option M)

The transducer has been preset with the regular internal sensitivity adjustment potentiometer. If remote sensitivity control is desired (Option M), connect the yellow, blue and violet\* leads and adjustable resistance as shown.

\*For Models 239 and 204 w/options E/G and M, replace violet lead as shown.



#### Remote calibration signal (option R)

Two types of calibration signal zero offset are offered:

**Fixed calibration signal** closing red to black leads.



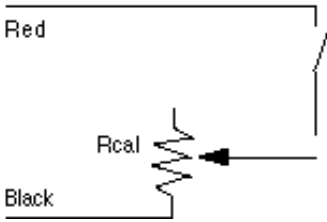

**Adjustable calibration signal**, on closing circuit with an adjustable resistance between red and black leads. Suggest use of a 100K potentiometer.

## 6.0 Installation instructions for multiple hook-up of 4-wire pressure transducers (24 VDC units only)

PS - Power supply (nominal 24 VDC)

PT - Pressure transducer (4-Wire Circuit)

DVM/DAS - Digital voltmeter or data acquisition system

### Option #1

Uses a single, ground referenced power supply for excitation and separate, isolated differential input (not ground referenced) readout or data acquisition system for each pressure transducer output.

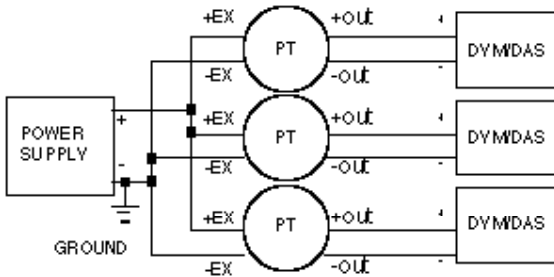

### Option #2

Uses a separate, isolated power supply for each pressure transducer's excitation and a single, ground reference (single ended input) readout or data acquisition system for all of the outputs.

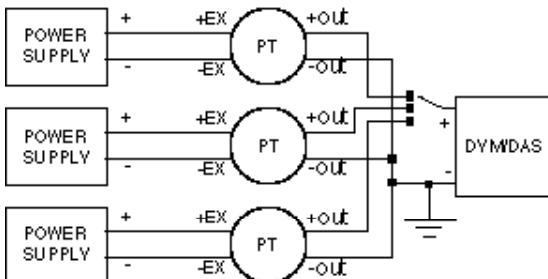

Option #3

Uses a single, ground referenced power supply for excitation and either a single, isolated readout with a bipolar switch that "breaks before makes" both the + output and the - output of each pressure transducer, or a single data acquisition system with a multiplexer (MUX)

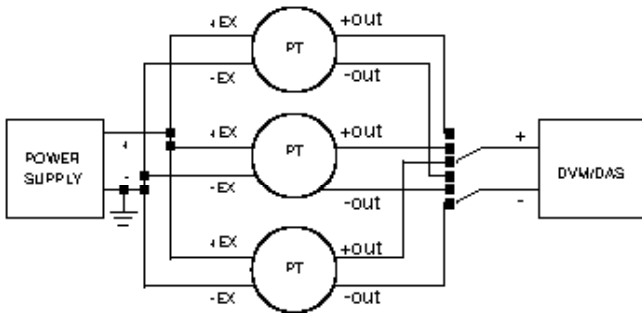

**Note:** The shield is internally commoned to the case and pressure port of the transducer. When the shield is connected to ground, the case and pressure port of the transducer will also be commoned to that ground.

# 7.0 Returning products for repair

Setra Systems cannot accept a Model 760 for repair unless the Form 760ERN is completed. Contact Setra Systems for an ERN number or the form 760ERN. Form 760ERN is included in this guide on page 15.

Please contact a Setra application engineer (800-257-3872, 978-263-1400) before returning unit for repair to review information relative to your application. Many times only minor field adjustments may be necessary. When returning a product to Setra, the material should be carefully packaged and shipped prepaid to:

Setra Systems, Inc.  
159 Swanson Road  
Boxborough, MA 01719-1304  
Attn: Repair Department

To ensure prompt handling, please supply the following information and include it inside the package or returned material:

- Name and phone number of person to contact.
- Shipping and billing instructions.
- Full description of the malfunctions.
- Identify any hazardous material used with the product.

### NOTES:

Please remove any pressure fittings and plumbing that you have installed and enclose any required mating electrical connectors and wiring diagrams.

Allow approximately 3 weeks after receipt at Setra for the repair and return of the unit. Non-warranty repairs will not be made without customer approval and a purchase order to cover repair charges.

### Calibration Services

Setra maintains a complete calibrations facility that is traceable to the National Institute of Standards and Technology (NIST). If you would like to recalibrate or recertify your Setra pressure transducers or transmitters, please call our Repair Department at 800-257-3872 (978-263-1400) for scheduling.

# 8.0 Limited warranty & limitation of repair

SETRA warrants its products to be free from defects in materials and workmanship, subject to the following terms and conditions: Without charge, SETRA will repair or replace products found to be defective in materials or workmanship within the warranty period; provided that:

- a) the product has not been subjected to abuse, neglect, accident, incorrect wiring not our own, improper installation or servicing, or use in violation of instructions furnished by SETRA;
- b) the product has not been repaired or altered by anyone except SETRA or its authorized service agencies;
- c) the serial number or date code has not been removed, defaced, or otherwise changed; and
- d) examination discloses, in the judgment of SETRA, the defect in materials or workmanship developed under normal installation, use and service;
- e) SETRA is notified in advance of and the product is returned to SETRA transportation prepaid.

Unless otherwise specified in a manual or warranty card, or agreed to in a writing signed by a SETRA officer, SETRA pressure and acceleration products shall be warranted for one year from date of sale.

The foregoing warranty is in lieu of all warranties, express, implied or statutory, including but not limited to, any implied warranty of merchantability for a particular purpose.

SETRA's liability for breach of warranty is limited to repair or replacement, or if the goods cannot be repaired or replaced, to a refund of the purchase price.

SETRA's liability for all other breaches is limited to a refund of the purchase price. In no instance shall SETRA be liable for incidental or consequential damages arising from a breach of warranty, or from the use or installation of its products.

No representative or person is authorized to give any warranty other than as set out above or to assume for SETRA any other liability in connection with the sale of its products.



**Setra Systems, Inc.**

159 Swanson Road, Boxborough, MA 01719  
800.257.3872 • [www.setra.com](http://www.setra.com)