

## Pro-8 Universal Industrial Controller

- BluePort Front interface and BlueControl software
  - Maintenance manager and error list
  - Start-up circuit and boost function
    - Two switchable parametersets
  - Self-Tuning to the setpoint without oscillation
  - Monitoring of heating current and output circuit
  - 3-point controller for water, fan and oil cooling
- Type tested to EN 14597 (replaces DIN 3440) & cULus

- ⊕ Universal continuous/switching version, i.e. reduced stocks
- ⊕ 100 ms cycle time, i.e. also suitable for fast control loops
- ⊕ 20ms as shortest pulse for very fast / strong actuators (e.g. infrared heater or water cooling)
- ⊕ Freely configurable analog output, e.g. as process value output
- ⊕ Customer-specific linearization for all sensors
- ⊕ Settings can be blocked via password and internal switch for high security
- ⊕ Extended temperature range up to 60 °C allows mounting close to the process
- ⊕ Easy 2-point or offset measurement correction
- ⊕ Emergency operation after sensor break by means of the „output hold“ function
- ⊕ Logical combination of digital outputs, e.g. for general alarm
- ⊕ Programmer with 10 segments and „end“ signal
- ⊕ RS 422/485 Modbus RTU interface
- ⊕ Built-in transmitter power supply
- ⊕ Splash-water proof front (IP 65)

### APPLICATIONS

- Furnaces and ovens
- Burners and boilers
- Plastics processing
- Hot runners
- Driers
- Climatic chambers
- Heat treatment plants

### DESCRIPTION

These universal temperature controllers are intended for precise, and cost-effective control tasks in all branches of industry. For this, the unit provides simple 2-point (on/off) control, continuous PID control, or 3-point stepping control. The process value signal is connected via a universal input. A supplementary analog input can be used for heating current measurement or as an external set-point input. All these controllers have at least three process outputs that can be 3 relays or 2 relays plus a universal output. This universal output can be used for operating a solid-state relay, a continuous current/voltage output or to energize a two-wire transmitter. Optionally there are two additional opto coupler outputs, that can be used freely.

The selectable function „start-up“ ensures increased lifetime of high-performance electrical heating elements (e.g. hot runner moulds).

### Plug-in module

Pro-8 controllers are built as plug-in modules. This enables them to be replaced very quickly without tools, and without disturbing the wiring.

### Self-tuning during start-up and to the setpoint

This new function determines the optimum settings for fast line-out without overshoot. With three-point controller configuration, the „cooling“ parameters are determined separately, thus ensuring an optimum match to the process. By pushing a button the controller determines the best control parameters at the actual setpoint. This function does not require oscillation, and performs a minimal deviation of the process value.

### Display and operation

Clear information are given by ten indicator LEDs in the front panel that display operating mode, I/O states, and errors. The automatic/manual-key switches the controller into the manual mode directly. If required, the direct switch over can be disabled or the key can be configured e.g. reset the latched alarms.

By the flexibly applicable function key an external switch can be omitted in many cases, because one can start now e.g. the boost function directly.

### Front interface and Engineering Tools

Control parameter adjustment in seconds has now also been implemented in the Pro-8 class of instruments.

Via the BlueControl software incl. its simulation functions, and especially the convenient BluePort front panel

interface, the required set-up for a specific control task can be determined without a detailed study of the operating instructions.

Off cause almost all adjustments can be done comfortably over the instrument front. (see page 7, BlueControl)

### Password protection

If required, the various operating levels can be protected with a password to prevent unauthorized access.

## TECHNICAL DATA

### INPUTS

### SURVEY OF THE INPUTS

Input	Used for:
INP1	x (process value)
INP2	Heating current, ext. set-point
di1	Operation disabled, switch-over to second set-point SP.2
di2 (option)	external set-point SP.E, fixed
di3 (option)	correcting variable Y2, manual operation, controller off, disable auto/manual function, reset of stored alarms, boost, parameter set 1 ↔ 2

### PROCESS VALUE INPUT INP1

Resolution:	> 14 bit
Decimal point:	0 to 3 decimals
Digital input filter:	adjustable 0,000...9999 s
Scanning cycle:	100 ms
Measured value correction:	2-point or offset correction

### Thermocouples (Table 1)

Input impedance:	$\geq 1 \text{ M}\Omega$
Effect of source resistance:	$1 \mu\text{V}/\Omega$

### Cold junction compensation

Max. additional error	$\pm 0,5 \text{ K}$
-----------------------	---------------------

### Sensor break monitoring

Sensor current:	$\leq 1 \mu\text{A}$
Operating sense configurable (see page 4)	

### Resistance thermometer

Connection:	3-wire
Lead resistance:	max. 30 $\Omega$
Input circuit monitor:	Break and short circuit

### Special measuring range

The BlueControl software can be used to match the input to the sensor KTY 11-6 (characteristic is stored in the controller).

Dimensions (mm):

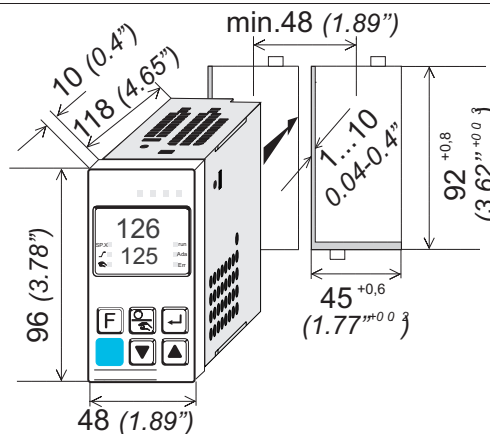

Electrical connections (part 1):

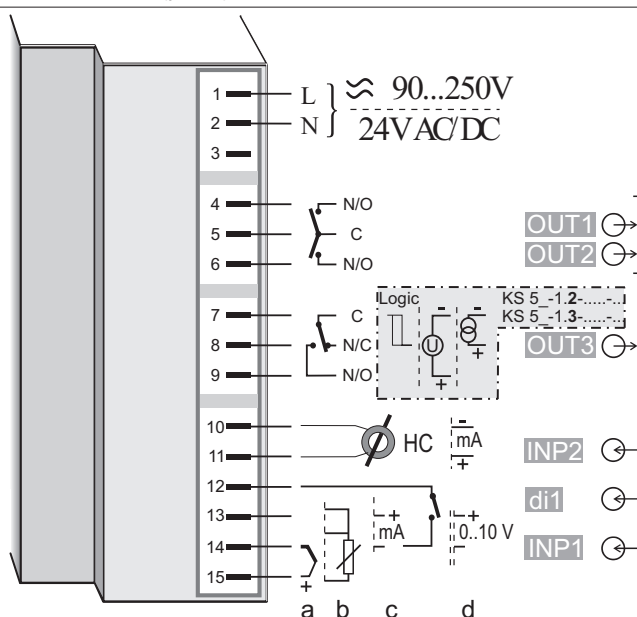

Electrical connections (part 2):

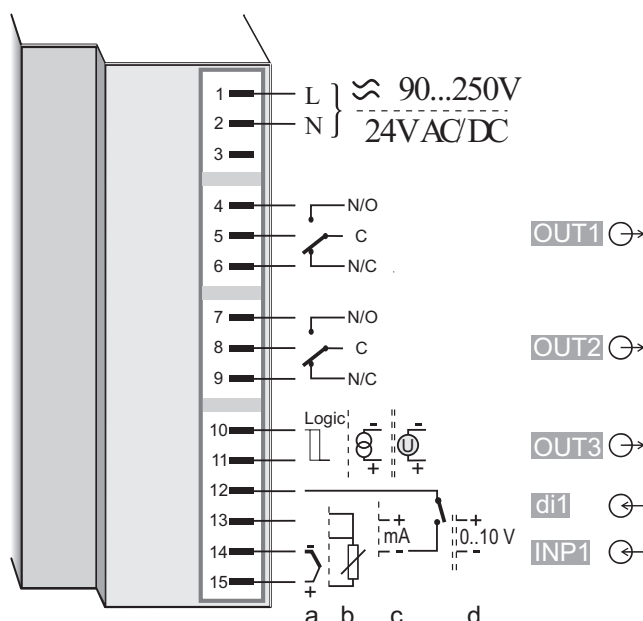

Physical measuring range: 0...4500 Ω

Linearization segments 16

**Current and voltage signals**

Span start, end of span: anywhere within measuring range

Scaling: selectable -1999...9999

Linearization: 16 segments, adaptable with BlueControl

Decimal point: adjustable

Input circuit monitor: 12,5% below span start (2mA, 1V)

**SUPPLEMENTARY INPUT INP2**

Resolution: > 14 bit

Scanning cycle: 100 ms

Accuracy: Better 0,1%

**Heating current measurement**

via current transformer

Measuring range: 0...50 mA AC

Scaling: adjustable -1999..0,000..9999 A

**Current measurement range**

Input resistance approx. 120 Ω

Span: configurable within 0 to 20mA

Scaling: adjustable -1999...9999

Input circuit monitor: 12,5% below span start (4..20mA < 2mA)

**CONTROL INPUT DI1**

Configurable as direct or invers switch or **push-button** !

Connection of a potential-free contact suitable for switching „dry“ circuits.

Switched voltage: 2,5 V

Switched current: 50 μA

**CONTROL INPUTS DI2, DI3 (OPTION)**

Configurable as direct or inverse, switch or push-button !

Optocoupler inputs for active triggering

**Pro-8**

(di2 and di3 24V contactinputs)

Nominal voltage: 24 V DC, external

Current sink (IEC 1131 Type 1)

Logic „0“: -3...5 V

Logic „1“: 15...30 V

Current requirement: approx. 5 mA

**Electrical connections (options):**

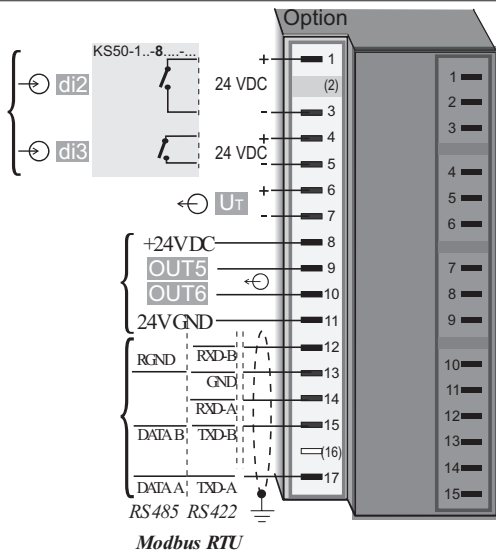

**Pro-8**

(di2 and di3 24V contactinputs)

Connection of a potential-free contact suitable for switching „dry“ circuits.

Switched voltage: 5 V

Switched current: 160 μA

**TRANSMITTER SUPPLY U<sub>T</sub> (OPTION)**

Output: 22 mA / ≤ 18 V

If the universal output OUT3 is used there may be no external galvanic connection between measuring and output circuits!

**OUTPUTS**

**SURVEY OF THE OUTPUTS**

Output	Used for
OUT1 OUT2 (relay)	Control output heating/cooling or Open/Close, limit contacts, alarms, programmer end *
OUT3 (Relay or logic)	as OUT1 and OUT2
OUT3 (continuous)	Control output, process value, set-point, control deviation, transmitter supply 13 V / 22 mA
OUT5 OUT6 (Optocoupler)	as OUT1 and OUT2

**OPTION**

\* All logic signals can be OR-linked !

Table 1 Thermocouple ranges

Thermocouple		Range		Accuracy	Resolution (∅)
L	Fe-CuNi (DIN)	-100...900 °C	-148...1652 °F	≤ 2 K	0,1 K
J	Fe-CuNi	-100...1200 °C	-148...2192 °F	≤ 2 K	0,1 K
K	NiCr-Ni	-100...1350 °C	-148...2462 °F	≤ 2 K	0,2 K
N	Nicrosil/Nisil	-100...1300 °C	-148...2372 °F	≤ 2 K	0,2 K
S	PtRh-Pt 10%	0...1760 °C	32...3200 °F	≤ 2 K	0,2 K
R	PtRh-Pt 13%	0...1760 °C	32...3200 °F	≤ 2 K	0,2 K
	special	-25 ...75 mV		≤ 0,1 %	0,01 %

Table 2 Resistance transducers

Type	Sensor current	Range		Accuracy	Resolution (∅)
Pt100	0,2 mA	-200...850 °C	-328...1562 °F	≤ 1 K	0,1 K
Pt1000		-200...200 °C	-328...392 °F	≤ 2 K	0,1 K
KTY 11-6*		-50...150 °C	-58...302 °F	≤ 2 K	0,05 K

Table 3 Current and voltage

Range	Input resistance	Accuracy	Resolution (∅)
0-10 Volt	≈ 110 kΩ	≤ 0,1 %	0,6 mV
0-20 mA	49 Ω (voltage requirement ≤ 2,5 V)	≤ 0,1 %	1,5 μA

Galvanic isolations:

- Safety isolation
- Functional isolation
- Pro-8 (di2 and di3 24V inputs)

Mains supply	Process value input INP1 Supplementary input INP2 Digital input di1
Relay outputs OUT1,2	RS 422/485 interface
Relay output OUT3	Digital inputs di2, 3
	Universal output OUT3 Transmitter supply $U_T$ OUT5, OUT6

Pro-8 (di2 and di3 24V contact inputs)

Example of the linkage of the internal functions:

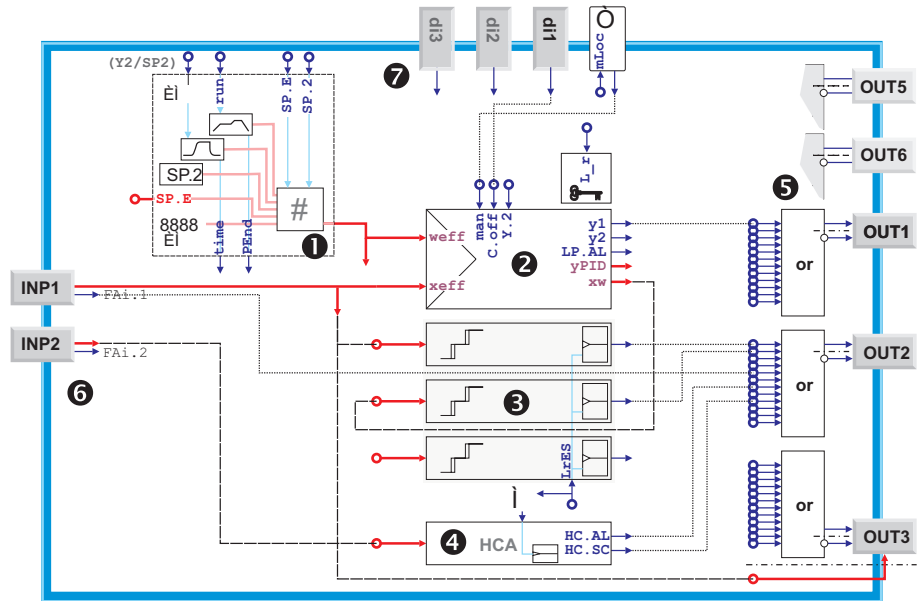

- 1 setpoint processing with programmer, boost function and start-up circuit
- 2 controller function with loop monitoring
- 3 limit monitoring, configurable with latch and suppression
- 4 heating current monitoring
- 5 output processing with logic or-combination and inverting
- 6 analog inputs with logical sensor fail signal

RELAY OUTPUTS OUT1, OUT2

Contacts: 2 NO contacts with common connection

Max. contact rating: 500 VA, 250 VAC, 2A at 48...62 Hz, resistive load

Min. contact rating: 6 V, 1 mA DC

Duty cycle electric for  $I = 1A/2A: \geq 800,000 / 500,000$  (at ~ 250V / (resistive load))

OUT3 USED AS RELAY OUTPUT

Contacts: Potential-free changeover contact

Max. contact rating: 500 VA, 250 VAC, 2A at 48...62 Hz, resistive load

Min. contact rating: 5 V, 10 mA AC/DC

Duty cycle electric for  $I = 1A/2A: \geq 1,000,000 / 600,000$  (at ~ 250V / (resistive load))

Note: If the relays OUT1...OUT3 operate external contactors, these must be fitted with RC snubber circuits to manufacturer specifications to prevent excessive switch-off voltage peaks.

Modbus Master function supports setpoint changes e.g. in extruder applications

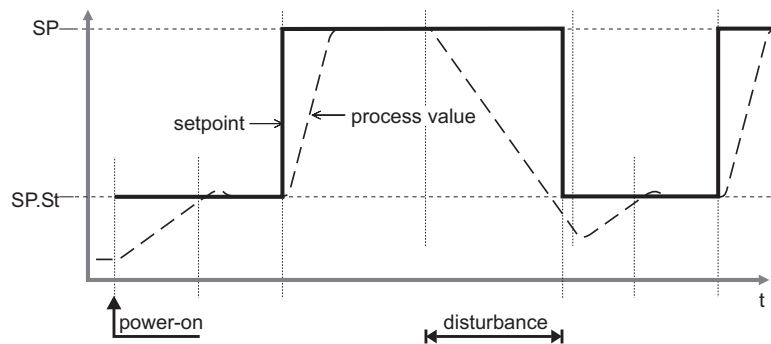
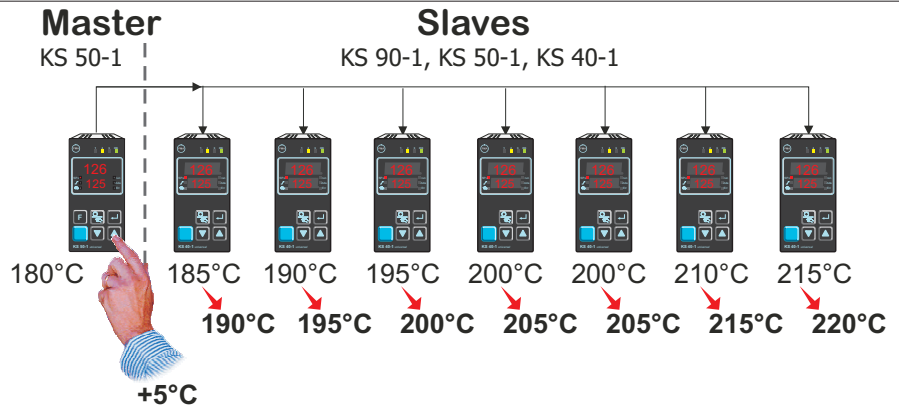

Start-up circuit

When the process is controlled towards the start-up set-point, the output value is limited. The start-up set-point is kept constant during the start-up holding time. After that, the main setpoint SP is controlled. If a disturbance reduced the process value, the start-up circuit is activated again.

## OUT3 AS UNIVERSAL OUTPUT

Galvanically isolated from the inputs.

Freely scalable  
 Resolution: 11 bit  
 Time constant of the AD-converter T90: 50 ms  
 Limit frequency of the whole continuous controller: > 2 Hz

### Current output

0/4...20 mA, configurable.  
 Signal range: 0...approx. 22 mA  
 Load:  $\leq 500 \Omega$   
 Load effect: none  
 Resolution:  $\leq 22 \mu\text{A}$  (0,1%)  
 Error:  $\leq 40 \mu\text{A}$  (0,2%)

### Voltage output

0/2...10V, configurable  
 Signal range: 0...11 V  
 Load:  $\geq 2 \text{ k}\Omega$   
 Load effect: none  
 Resolution:  $\leq 11 \mu\text{V}$  (0,1%)  
 Error:  $\leq 20 \mu\text{V}$  (0,2%)

### OUT3 as transmitter supply

Output: 22 mA /  $\geq 13 \text{ V}$

### OUT3 as logic output

Load  $\leq 500 \Omega$  0 /  $\leq 20 \text{ mA}$   
 Load  $> 500 \Omega$  0 /  $> 13 \text{ V}$

## OUTPUTS OUT5, OUT6 (OPTIONAL)

Galvanically isolated opto-coupler outputs.  
 Grounded load:  
 common positive control voltage.  
 Output rating: 18...32 VDC; =70 mA  
 Internal voltage drop: =1 V with  $I_{\text{max}}$   
 Protective circuit: built-in against short circuit, reversed polarity.

Node: For inductive load a free-wheel diode has to be connected externally.

## FUNCTIONS

### Control behaviour

- Signaler with adjustable switching differential (ON/OFF controller)
- PID controller (2-point and continuous)
- Delta / Star / Off or 2-point controller with switch over from partial to full load
- 2 x PID (heating/cooling)
- 3-point stepping controller

Display and operation:

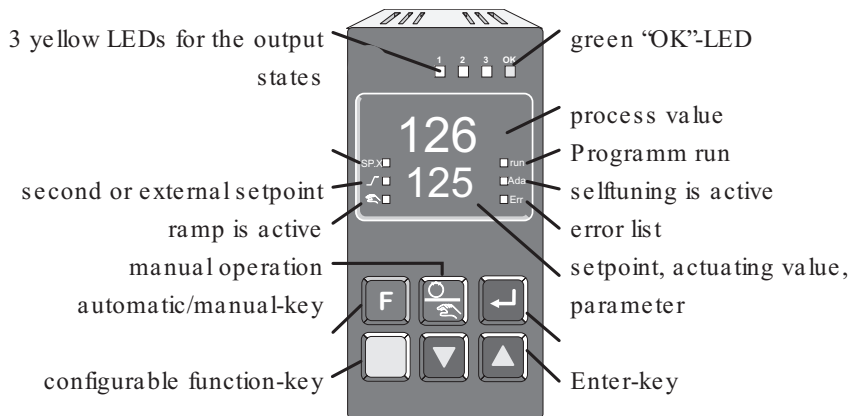

Two parameter sets for manual gain scheduling  
 Self-tuning control parameters or adjustable manually via front keys or BlueControl software.

### Behaviour with 2- and 3-point controllers

- **Standard behaviour:**  
 For precise matching of the required output value at the output signal limits, the controller changes the cycle times for heating and cooling automatically and continuously.
- **With constant cycle times:**  
 The length of the shortest heating and cooling pulse is adjustable.
- **Water cooling linear (heating=standard):**  
 To ensure a sufficient cooling effect, the cooling function starts only after reaching an adjustable temperature value. The pulse length is adjustable, too and remains constant for all output values.
- **Water cooling nonlinear (heating=standard):**  
 The general function is described above but the controller additionally takes in consideration that the water cooling is usually much stronger than the heating (thus preventing unfavorable behavior when changing from heating to cooling).

### Set-point functions

- Adjustable set-point gradient 0,01...9999 °C/min
- Set-point control
- Set-point/cascade control
- Program controller with 4 segments (set-point/section time)

### Behaviour with sensor break or short circuit:

- Control outputs switched off
- Switch-over to a safe output value
- Switch-over to a mean output value (PID controller)

Flashing Error LED indicates active alarm in the error list:

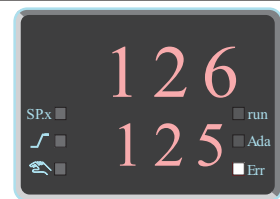

## SPECIAL FUNCTIONS

### Boost-Function

The boost function provides a short-term increase of the set-point, e.g. with hot runner control, in order to clear nozzles of "frozen" rests of material.

### Start-up circuit

For temperature control, e.g. with hot runners.  
 High-performance heating elements with magnesium oxide insulation must be heated slowly, to remove any humidity and to prevent destruction.

### Modbus Master

The Pro-8 can be configured as Modbus Master.  
 This enables it to transmit user-specified signals or parameters cyclically to all connected Slave controllers.  
 For example, the following applications are possible:

- Set-point shifting relative to the set-point adjusted in the Slave (see picture)
- matching of control parameters, limit contacts, etc.
- Limiting the output value (override control OVC)
- ...

## LIMIT SIGNALLING FUNCTIONS

Max., Min. or Max./Min. monitoring with adjustable hysteresis.



### Signals which can be monitored:

- Process value
- Control deviation
- Control deviation with suppression during start-up or set-point changes
- Effective set-point
- Output signal Y
- Control deviation always compared to internal setpoint SP even if SP2 or SP.E is activated.

### Functions

- Input signal monitoring
- Input signal monitoring with latch (reset via front key or digital input)

Several limit signals or alarms can be OR-linked before being output.

Applications: Release of a brake with motor actuators, general alarms, etc.

### ALARMS

#### Heating current alarm

- Overload and short circuit
- Open circuit and short circuit

Limit value adjustable 0...9999 A

#### Control loop alarm

Automatic detection if there is no response of the process to a change of output value.

#### Sensor break or short circuit

Depending on selected input type, the input signal is monitored for break and short circuit.

### MAINTENANCE MANAGER

Display of error signals, warnings, and latched limit messages in the error list. Signals are latched, and can be reset manually.

Possible signals in the error list:

Sensor break, short circuit, reversed polarity
Heating current alarm
Control loop alarm
Fault during self-tuning
latched limit messages e.g. re-calibration warning (If the adjusted operating hours are exceeded a message is displayed)
e.g. maintenance interval of actuator (If the adjusted switching cycles are exceeded a message is displayed)
Internal fault (RAM, EEPROM, ...)

### OPERATION AND DISPLAY

#### Display

Process value: LED with 7 segments, 10,5 mm  
Lower display: LED with 7 segments, 7,8 mm

#### Operating functions

The functions of the Ò-key and the è-key are configurable:

Function	Ò	è
Remote (no front operation)		X
SP.2 (2nd setpoint)		X
Y.2 (2nd output value)	X	X
SP.E (external setpoint)	X	X
Manual operation	X	X
C.OFF (controller function off)	X	X
Lock of manual key		X
Reset of latched limits and error list	X	X
Boost		X
Parameter set ½		X
Programmer run/stop		X

Several functions can be combined e.g. SP.2 and parameter set switch-over (gain scheduling) with only one key.

### POWER SUPPLY

Depending on version:

#### AC SUPPLY

Voltage: 90...260 VAC  
Frequency: 48...62 Hz  
Power consumption: approx. 7 VA

#### UNIVERSAL SUPPLY 24 V UC

AC voltage: 20,4...26,4 VAC  
Frequency: 48...62 Hz  
DC voltage: 18...31 V DC  
Power consumption: approx. 7 VA (W)

#### BEHAVIOUR WITH POWER FAILURE

Configuration, parameters, and adjusted set-points, control mode:  
Non-volatile storage in EEPROM

#### BluePort FRONT INTERFACE

Connection of PC via PC adapter (see „Accessories“). The BlueControl software is used to configure, set parameters, and operate the Pro-8.

#### BUS INTERFACE (OPTION)

Galvanically isolated  
Physical: RS 422/485

Protocol: Modbus RTU  
Transmission speed: 2400, 4800, 9600, 19.200 bits/s  
Address range: 00...99  
Number of controllers per bus: 32  
Repeaters must be used to connect more controllers.

### ENVIRONMENTAL CONDITIONS

#### Protection modes

Front panel: IP 65 (NEMA 4X)  
Housing: IP 20  
Terminals: IP 00

#### Permissible temperatures

For specified accuracy: 0...60°C  
Warm-up time: < 15 minutes  
Temperature effect: < 100ppm/K  
For operation: -20...65°C  
For storage: -40...70°C

#### Humidity

75% yearly average, no condensation

#### Shock and vibration

##### Vibration test Fc (DIN 68-2-6)

Frequency: 10...150 Hz  
Unit in operation: 1g or 0,075 mm  
Unit not in operation: 2g or 0,15 mm

##### Shock test Ea (DIN IEC 68-2-27)

Shock: 15g  
Duration: 11ms

#### Electromagnetic compatibility

Complies with EN 61 326-1

- Complies with the immunity requirements for continuous, unattended operation
- Complies with the emission requirements class B for rural areas
- Surge disturbances may increase the measurement error and lead to error messages

### GENERAL

#### Housing

Material: Makrolon 9415, flame-retardant  
Flammability class: UL 94 VO, self-extinguishing

Plug-in module, inserted from the front

#### Safety tests

Complies with EN 61010-1 (VDE 0411-1):  
 Over voltage category II  
 Contamination class 2  
 Working voltage range 300 VAC  
 Protection class II

**Certifications**

Type tested to EN 14597 (replaces DIN 3440)

With certified sensors iapplicable for:

- Heat generating plants with outflow temperatures up to 120°C to DIN 4751
- Hot-water plants with outflow temperatures above 110°C to DIN 4752
- Thermal transfer plants with organic transfer media to DIN 4754
- Oil-heated plants to DIN 4755

**CULus-certification**

(Front Panel-mounted Type1, indoor use)

**GOST-R Certificate: (on request)**

For each shipment to the russian federation and GUS-states, an authenticated certificate is to be delivered with the GOST-R certificated controlllers (Pro-4, Pro-8, Pro-16, one certificate per shipment - 9499-047-14465).

**Electrical connections**

Depending on version:

- Flat-pin connectors 1 x 6,3 mm or 2 x 2,8 mm to DIN 46 244
- Screw terminals for conductor cross-section from 0,5 to 2,5 mm²

For device with screw terminals the length of the removed insulation must be at least 12mm. The cable end sleeve must be chosen accordingly.

**Mounting**

Panel mounting with two fixing clamps at top/bottom or left/right  
 Close mounting possible

Mounting position: not critical

Weight: 0,27 kg (9.52 oz)

**Accessories supplied with unit**

Operating instructions  
 2 fixing clamps

**ACCESSORY EQUIPMENT**

**BlueControl (Engineering Tool)**

PC-based program for configuring, setting parameters, and operating (commissioning) the Pro-8 controller. Moreover, all the settings are saved, and can be printed on demand.

BlueControl, versions and functionality:

Functionality	Mini	Basic	Expert
Parameter and configuration setting	yes	yes	yes
Controller and loop simulation	yes	yes	yes
Download: transfer of an engineering to the controller	yes	yes	yes
Online mode / visualization	SIM only	yes	yes
Defining an application specific linearization	yes	yes	yes
Configuration in the extended operating level	yes	yes	yes
Upload: reading an engineering from the controller	SIM only	yes	yes
Basic diagnostic functions	no	no	yes
Saving data file and engineering	no	yes	yes
Printer function	no	yes	yes
Online documentation, help	yes	yes	yes
Implementation of measurement value correction	yes	yes	yes
Data acquisition and trend display	SIM only	yes	yes
Wizard function	yes	yes	yes
Extended simulation	no	no	yes
Programeditor Pro 4  programmer only)	no	no	yes

Depending on version, a powerful data acquisition module is available, complete with trend graphics.

**Visibility mask**

The BlueControl software can be used to blind out any parameters in the instrument. Thus, only allowed parameters can be changed on side. Safety relevant parameters are invisible!

Two parameters are blinded out:

Name	Description	Visible
Setp	Setpoint	<input checked="" type="checkbox"/>
SP.Lo	lower setpoint range	<input type="checkbox"/>
SP.Hi	upper setpoint range	<input type="checkbox"/>
SP.2	2nd setpoint	<input checked="" type="checkbox"/>
r.SP	setpoint ramp [/min]	<input checked="" type="checkbox"/>
t.SP	timer dwell time [min]	<input checked="" type="checkbox"/>

**Simulation**

The built-in simulation serves to test the controller settings, but can also be used for general training and observing the interaction between controller and control loop.

**Software requirements:**

Windows 95/98/NT/2000.

The built-in simulation serves to test the controller settings, but can also be used for general training and observing the interaction between controller and control loop.

*Configurations that can only be implemented via the BlueControl software (not via the front-panel keys):*

- Customer-specific linearizations
- Enable „forcing“ for inputs/outputs. Forcing allows to write the analog and digital inputs and outputs via Modbus interface.
- Adjustment of limits for operating hours and switching cycles
- Switch-over to 60 Hz mains frequency
- Master/slave configuration
- Disable operator actions and operating levels, plus password definition
- Prevent automatic optimization of cycle times T1, T2

**Hardware requirements:**

A PC adapter (see „Accessories“) is required for connecting the controller.

Updates and demo software can be downloaded from: [www.West-CS.com](http://www.West-CS.com)

K S 5 - 1 - 0 0 - U69

Format 48 x 96	0	↑	↑	↑	↑	↑
Flat pin connector	0					
Screw terminals	1					
90..250VAC, INP2, 3 relays	0					
24VAC/ 18..30VDC, INP2, 3 relays	1					
90..250VAC, INP2, 2 relays+ mA/V/logic	2					
24VAC/ 18..30VDC, INP2, 2 relays+ mA/V/logic	3					
90..250VAC, 2 relays (Wechsler)+ mA/V/logic	4					
No option	0					
Modbus RTU+ U <sub>T</sub> + di2/3 + OUT5/6	1					
U <sub>T</sub> + di2/3 + OUT5/6	8					
Standard configuration						0
Configuration to specification						9
No manual						0
Manual english						E

### ACCESSORIES

Description	Order no.
Current converter 50A AC	9404-407-50001
PC adapter, for connecting the BlueControl software to the BluePort	9407-998-00001
Standard rail adapter	9407-998-00061
Operating manual	English 9499-040-62811
BlueControl Mini	German/English/French www.West-CS.com
BlueControl Basic	German/English/French 9407-999-11001
BlueControl Expert	German/English/French 9407-999-11011
BlueControl Universal	German/English/French 9407-999-19011



www.West-CS.com

West Control Solutions  
1675 Delany Road  
Gurnee  
Illinois 60031  
USA  
T: +1 800 866 6659  
E: Inquiries@West-CS.com

Your local representative: