

WEST

Pro-16

Pro-16 Industrial Controller User Guide



Manual Part number: 59537-1
October 2013



WEST  **Parlow**

© West Control Solutions

All rights reserved. No part of this document may be reproduced or published in any form or by any means without prior written permission from the copyright owner.

A publication of West Control Solutions
P.O.Box 310229
D-34058 Kassel
Germany

Table of contents

1. Mounting	6
2. Electrical connection	8
3. Operation	9
3.1 Front view	9
3.2 Operating structure	9
3.2.1 Operating Level	10
3.3 Behaviour after power-on	10
3.4 Operating level	11
3.5 Errorlist / Maintenance Manager	12
3.5.1 Error-List:	12
3.5.2 Error-Status (Self-tuning)	13
3.6 Function level	14
3.7 Self-tuning	15
3.7.1 Preparation before self-tuning	15
3.7.2 Optimization after start-up or at the set-point	16
3.7.3 Selecting the method (ConF/ Cntr/ tunE)	16
3.7.4 Step attempt after start-up	17
3.7.5 Pulse attempt after start-up	17
3.7.6 Optimization at the set-point	17
3.7.7 Self-tuning start	20
3.7.8 Examples for self-tuning attempts	20
3.8 Help for manual tuning	22
3.9 Second PID parameter set	23
3.10 Alarm handling	24
4. Configuration level	26
4.1 Configuration overview	26
4.2 Configurations	27
4.3 Set-point processing	42
4.3.1 Set-point gradient / ramp	42
4.3.2 Cooling functions	42
4.3.3 Standard (CyC1=0)	42
4.3.4 Switching attitude linear (CyC1=1)	43
4.3.5 Switching attitude non-linear (CyC1=2)	44
4.3.6 Heating and cooling with constant period (CyC1=3)	45

4.4	Configuration examples	46
4.4.1	On-Off controller / Signaller (inverse)	46
4.4.2	2-point and continuous controller (inverse)	47
4.4.3	3-point and continuous controller	48
4.4.4	3-point stepping controller (relay & relay)	49
4.4.5	- Y - Off controller / 2-point controller with pre-contact	50
4.4.6	KS 20-1 with measured value output	51
5.	Parameter-Level	52
5.1	Parameter-Overview	52
5.2	Parameter	53
6.	Input scaling	57
7.	Calibration level	58
8.	Programmer	61
8.1	Operation	61
8.1.1	Programmer display	62
8.1.2	Segment type	62
8.1.3	Bandwidth monitoring	63
8.1.4	Search run at programmer start	64
8.1.5	Behaviour after mains recovery or sensor error	64
8.2	Parameter overview	65
8.3	Parameter	66
8.4	Programmer description	68
8.4.1	General	68
8.4.2	Programmer set-up:	69
9.	Special functions	71
9.1	Start-up circuit	71
9.2	Boost function	72
9.3	KS 20-1 as Modbus-Master	73
9.4	Linearization	74
9.5	Timer	75
9.5.1	Setting up the timer	75
9.5.2	Determining the timer run-time	76
9.5.3	Starting the timer	77
10.	Ordering information	78
11.	BlueControl®	79
11.1	Configuration Port	80

12. Technical Data	81
13. Safety notes	84
13.1 Resetting to factory setting	86

1. Mounting

	<p>CAUTION</p> <p>Make sure that the inside of the mounting plate corresponds to the instrument operating temperature and that sufficient ventilation to prevent overheating is provided.</p> <p>Please, DON'T remove the safety device/sealing of the mounting plate, in order to avoid jamming of the instrument in the mounting plate.</p>
---	---

The mounting plate must be solid and up to 6.0 mm thick. The required cut-out is shown below. Several instruments with the following dimensions can be installed side by side:
Instruments: (48n - 4) mm or (1.89n - 0.16) inches.

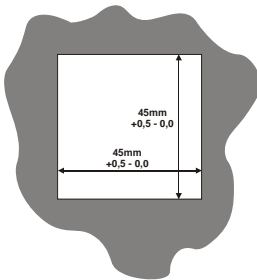

Fig. 1: Mounting dimensions

Mounting dimensions

The mounting depth with terminals plugged in is 110mm.

1. Insert instrument into the panel cut-out.
2. Hold front bezel firmly (*without pressing on display area*), and re-fit mounting clamp. Push clamp forward, using a tool if necessary, until gasket is compressed and instrument held firmly in position.

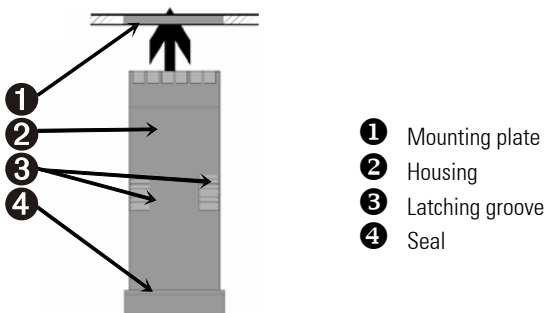
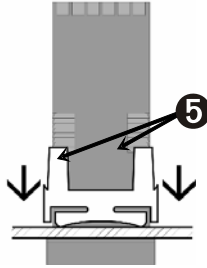

Fig. 2: Orientation



- 5** Slip the mounting clip from behind onto the housing until the spring tab snaps in the latch.

Fig. 3: Mounting clip

After installing the instrument in the mounting plate, it may be removed from its housing, if necessary (see the information on fitting and removing the optional modules).

NOTE!



The flanges of the mounting clip lock in position on both sides or on the top and bottom side of the instrument housing. For optimum performance it is important to use the latches on the sides of the instrument.

2. Electrical connection

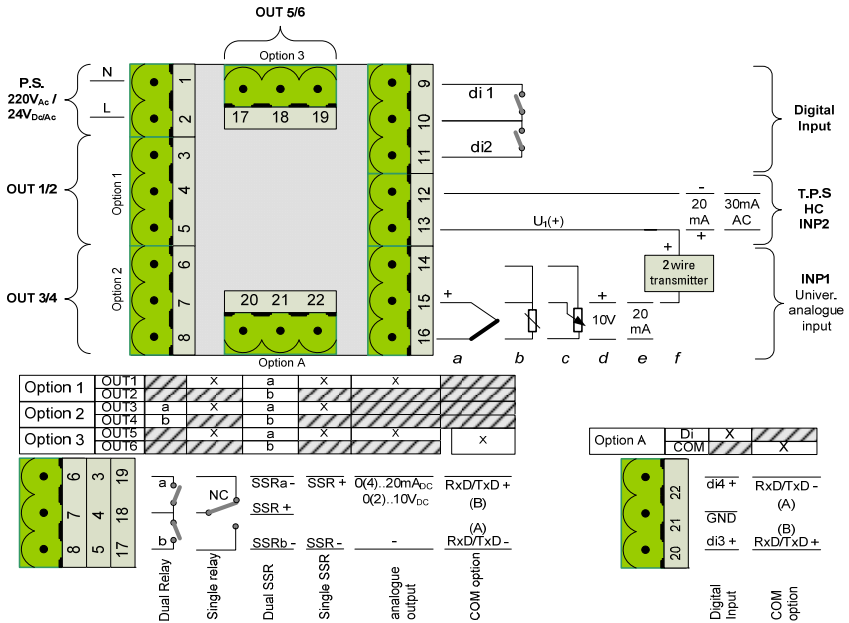

Fig. 4: Electrical connection

Connection of input INP1

Input for variable x1 (process value)

- a thermocouple
- b resistance thermometer (Pt100/ Pt1000/ KTY/ ...)
- c potentiometer
- d voltage (0/2...10V)
- e current (0/4...20mA)
- f Transmitter Power Supply

Connection of input INP2

current (0/4...20mA and 0...30mA AC).

Connection of inputs di1/di2/di3 and di4

Digital inputs for switching functions, e.g. **SP** and **SP.2/SP.e** or programmer **Run/Stop/Reset**.

3. Operation

3.1 Front view



Fig. 5: Front view

- 1 Process value display
- 2 Set-point, controller output, parameter
- 3 Status of switching outputs
- 4 Gradient is active
- 5 Manual mode
- 6 Timer or programmer is running
- 7 Set-point **SP.2** oder **SP.e** is effective
- 8 Function key
- 9 Changing the set-point or the controller output value
- 10 Acknowledges alteration of a value or shows the next parameter/value

In the upper display line, the process value is always displayed. At parameter, configuration, calibration as well as extended operating level, the bottom display line changes cyclically between parameter name and parameter value.

3.2 Operating structure

After supply voltage switch-on, the controller starts with the operating levels. The controller status is as before power off.

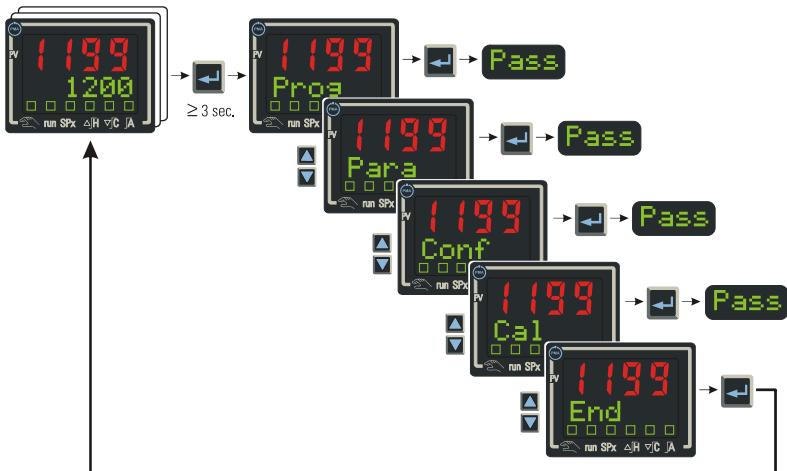

Fig. 6: Complete operating structure (depending on configuration)

The setting in the function level or in BlueControl® (engineering tool), individual layers can be locked or made accessible by entering the password in.

Individual parameters accessible without password must be copied to the extended operating level via BlueControl®.

When supplied, all levels are fully accessible,

Password **PASS = OFF**

3.2.1 Operating Level

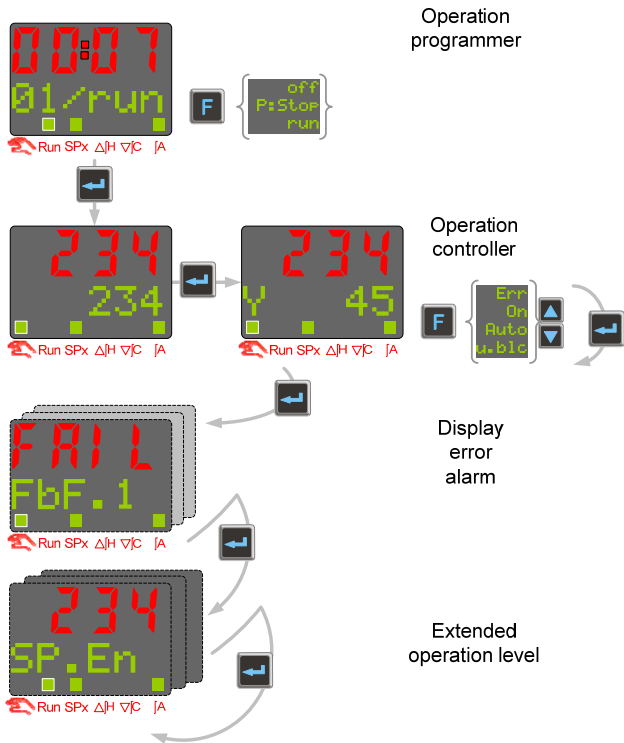

- See also chapter 3.4 Operating level
- And chapter 3.6 Function level

3.3 Behaviour after power-on

After supply voltage switch-on, the unit starts with the **operating level**.

The unit is in the condition which was active before power-off.

If the controller was in manual mode before power-off, the controller starts with the last correcting value after switching on again.

3.4 Operating level

The operating level comprises two views for setpoint and controller output value. The operating level can be enhanced with two levels

- Extended operating level
- Function level (see chapter 3.6)

The content of the extended operating level and the function level is determined by means of BlueControl (engineering tool). Parameters which are used frequently or the display of which is important can be copied to the extended operating level.

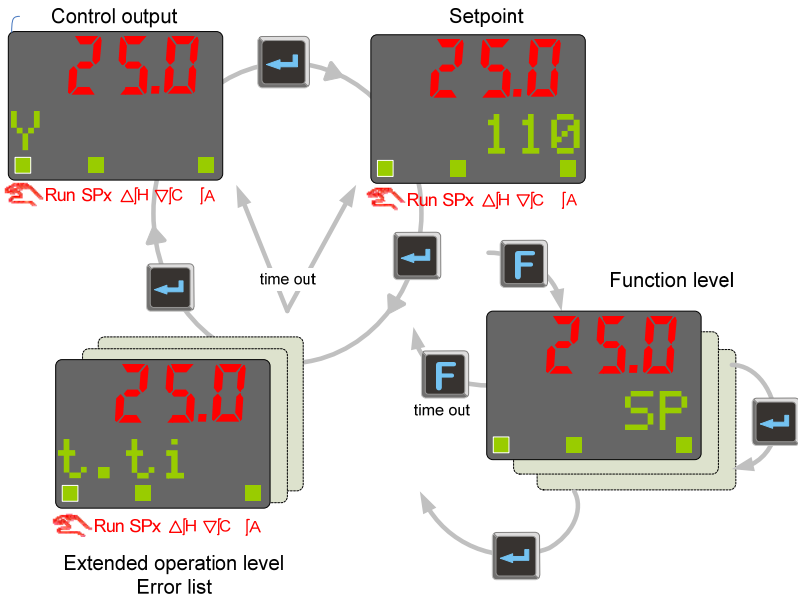



Fig. 7: Operating level and function level

3.5 Errorlist / Maintenance Manager

The error list is visible only if an error entry is present. An active entry in the error list is displayed by a red/green blinking 2nd line and status LED's in the display.

Err-Status	Signification	Proceed as follows
2. line blinks red	existing error	- determine the error type in the error list via the error number - remove error
.. is red	error removed	- Acknowledge the alarm in the error list by pressing key  - or  - The alarm entry is deleted.
.. is green	no error	

All errors can be reset in the function level with **Err**  **rSET** (if configured).

3.5.1 Error-List:

Name	Description	Cause	Possible remedial action
E. 1	Internal error, cannot be removed	E.g. defective EEPROM	Contact PMA service Send- in device
E. 2	Internal error, can be reset	e.g. EMC trouble	-shortly separate the device from mains supply - Keep measurement and power supply cables in separate runs
E. 4	Internal error, option modules	HW-Coding does not match the current recognized HW configuration	- Contact PMA service, send-in device or check option modules
FBF. 1/2	Sensor break INP1/2	Sensor defectiveFaulty cabling	Replace INP1/2 sensor Check INP1/2 connection
Sh.t. 1/2	Short circuit INP1/2	Sensor defectiveFaulty cabling	Replace INP1/2 sensor Check INP1/2 connection
POL. 1	INP1 polarity error	Faulty cabling	Reverse INP1 polarity
HCA	Heating current alarm	- Heating current circuit interrupted, $I < HC.A$ or $I > HC.A$ (dependent of configuration) - Heater band defective	-Check heating current circuit - If necessary, replace heater band
SSR	Heating current short circuit	- Current flow in heating	- Check heating current circuit - If necessary, replace solid-

Operation

		circuit at controller off - SSR defective	state relay
Loop	Control loop alarm	- Input signal defective or not connected correctly - Output not connected correctly	- Check heating or cooling circuit - Check sensor and replace it, if necessary - Check controller and switching device
AdA.H	Self-tuning heating alarm (ADAH)	See Self-tuning heating error status	see Self-tuning heating error status
AdA.C	Self-tuning cooling alarm (ADAC)	See Self-tuning cooling error status	See Self-tuning cooling error status
Lim. 1/2/3	stored limit alarm	adjusted limit value 1/2/3 exceeded	check process
Inf. 1	time limit value message	adjusted number of operating hours reached	application-specific
Inf. 2	duty cycle message (digital outputs)	adjusted number of duty cycles reached	application-specific

3.5.2 Error-Status (Self-tuning)

(error status 3 - 9 only with error **AdA.H / AdA.C**):

Err-Status	Description	Behaviour
1	Stored error	Delete the entry after acknowledgment
2	Existing error	Change to error status 1 after error removal
3	Faulty control action	Re-configure controller (inverse ↔ direct)
4	No response of process variable	The control loop is perhaps not closed: check sensor, connections and process
5	Low reversal point	Let process cool down and start new adaptation attempt
6	Danger of exceeded set-point (parameter determined)	If necessary, increase (inverse) or reduce (direct) set-point
7	Output step change too small	Let process cool down and start new adaptation attempt
8	Set-point reserve too small	Increase set-point (invers), reduce (direkt)
9	Impulse tuning failed	The control loop is perhaps not closed: check sensor, connections and process

3.6 Function level

Switching functions via **F** key.

The function level serves for the enhanced operation of the device. You can switch functions such as manual / automatic, Sollwert/Sp.2/Sp.E, ... via the operation level on the controller are performed. It's content is determined by configuration (**LOGI**):

Err	No reset of the error list	Off	Controller/Signaller and Limit 1 are switched off
Ereset	Resetting thr error list	Auto	Automatic operation
SP	Internal setpoint active	Man	Manual operation
SP.E	External setpoint active	Bo.Off	Boost function not active
SP.2	2nd setpoint active	Bo.On	Boost function active
Y	Internal correcting variable	Para.1	First parameter set active
Y2	2. correcting variable	Para.2	Second parameter set active
Y.ext	External correcting variable	Loc	Local-operation adjustment via front-panel possible
On	Controller/Signaller and Limit 1 are active	rem	Remote-operation adjustment via front-panel not possible

In the sequence above the list can be scrolled with the **F**-key. With the keys **▼▲** values are adjusted, with **↵** or latest 2 seconds after adjustment, the value is taken over. Pressing key **F** returns to normal operation.

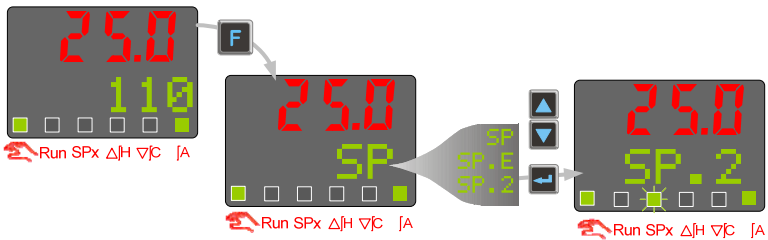

Example (switching from internal setpoint to SP.2)

3.7 Self-tuning

(automatic adaption of control parameters)

For determination of optimum process parameters, self-tuning is possible.

After starting by the operator, the controller makes an adaptation attempt, whereby the process characteristics are used to calculate the parameters for fast line-out to the set-point without overshoot.

- The following parameters are optimized when self-tuning:

Parameter set 1:

Pb1	Proportional band 1 (heating) in engineering units [e.g. °C]
ti1	Integral time 1 (heating) in [s] → only, unless set to OFF
td1	Derivative time 1 (heating) in [s] → only, unless set to OFF
t1	Minimum cycle time 1 (heating) in [s]. This parameter is optimized only, unless parameter Cntr/Adt0 was configured for "no self-tuning" using BlueControl®
Pb2	Proportional band 2 (cooling) in engineering units [e.g. °C]
ti2	Integral time 2 (cooling) in [s] → only, unless set to OFF
td2	Derivative time 2 (cooling) in [s] → only, unless set to OFF
t2	Minimum cycle time 2 (cooling) in [s]. This parameter is optimized only, unless parameter Cntr/Adt0 was configured for "no self-tuning" using BlueControl®

- Parameterset 2: according to Parameterset 1 (see page 23)

3.7.1 Preparation before self-tuning

- The limits of the control range must be adjusted for the controller operating range, i.e. **rng.L** and **rng.H** must be adjusted to the limits within which control must take place Configuration→Controller→span start and end of control range)
ConF→**Cntr**→**rng.L** and **rng.H**
- Determine which parameter set must be optimized.
 - The currently effective parameter set is optimized.
 - activate the corresponding parameter set (1 or 2).
- Determine which parameter must be optimized (see the list given above)
- Select the method for self-tuning (See Chapter 3.7.616)
 - Step attempt after start-up
 - Pulse attempt after start-up
 - Optimization at the set-point

3.7.2 Optimization after start-up or at the set-point

There are two methods of optimization; either after start-up or at the set-point. As control parameters are always optimal only for a limited process range, various methods can be selected dependent of requirements. If the process behavior is very different after start-up and directly at the set-point, parameter sets 1 and 2 can be optimized using different methods. Switch-over between parameter sets dependent of process status is possible (see page 23).

- **Optimization after start-up: (see page 17)**

Optimization after start-up requires a certain separation between process value and set-point. This separation enables the controller to determine the control parameters by evaluation of the process whilst progressing to the set-point. This method optimizes the control loop from the start conditions to the set-point, whereby a wide control range is covered. We recommend selecting optimization method "Step attempt after start-up" with **tunE** = 0 first. Unless this attempt is completed successfully, we then recommend a "Pulse attempt after start-up".

- **Optimization at the set-point: (see page 17)**

For optimizing at the set-point, the controller outputs a disturbance variable to the process. This is done by briefly changing the output variable. The process value changed by this pulse is evaluated. The detected process parameters are converted into control parameters and saved in the controller. This procedure optimizes the control loop directly at the set-point. The advantage is in the small control deviation during optimization.

3.7.3 Selecting the method (Conf/ Cntr/ tunE)

Selection criteria for the optimization method:

tunE	Step attempt after start-up	Pulse attempt after start-up	Optimization at the set-point
= 0	sufficient set-point reserve is provided		sufficient set-point reserve is not provided
= 1		sufficient set-point reserve is provided	sufficient set-point reserve is not provided
= 2	Only step attempt after start-up required		

Sufficient set-point reserve:

inverse controller: process value is (10% of **rnGH** - **rnGL**) below the set-point
 direct controller: process value is (10% of **rnGH** - **rnGL**) above the set-point

3.7.4 Step attempt after start-up

Condition: - **tunE** = 0 and sufficient set-point reserve provided
or - **tunE** = 2

The controller outputs 0% correcting variable or **Y.Lo** and waits, until the process is at rest (see start-conditions on page 15).

Subsequently, a correcting variable step change to 100% or **Y.Hi** is output.

The controller attempts to calculate the optimum control parameters from the process response. If this is done successfully, the optimized parameters are taken over and used for line-out to the set-point.

With a 3-point controller, this is followed by "cooling".

After completing the 1st step as described, a correcting variable of -100% or **Y.Lo** (100% cooling energy) is output from the set-point. After successful determination of the "cooling parameters", the controller will proceed to the setpoint using the optimized parameters.

3.7.5 Pulse attempt after start-up

Condition: - **tunE** = 1 and sufficient set-point reserve provided.

The controller outputs 0% correcting variable or **Y.Lo** and waits, until the process is at rest (see start conditions page 15)

Subsequently, a short pulse of 100% or **Y.Hi** is output (Y=100%) and reset.

The controller attempts to determine the optimum control parameters from the process response. If this is completed successfully, these optimized parameters are taken over and used for stabilized to the set-point.

With a 3-point controller, this is followed by "cooling".

After completing the 1st step as described and stabilized to the set-point, correcting variable "heating" remains unchanged and a cooling pulse (100% cooling energy) is output additionally. After successful determination of the "cooling parameters", the optimized parameters are used for stabilized to the set-point.

3.7.6 Optimization at the set-point

Conditions:

- A sufficient set-point reserve is not provided at self-tuning start (see page 16).
- **tunE** is 0 or 1
- With **Strt** = 1 configured and detection of a process value oscillation by more than $\pm 0,5\%$ of (**rng.H** - **rng.L**) by the controller, the control parameters are preset for process stabilization and the controller realizes an optimization at the set-point (see figure "Optimization at the set-point").
- when the step attempt after power-on has failed

- with active gradient function (PARA/SETP/r.SP ≠OFF), the set-point gradient is started from the process value and there isn't a sufficient set-point reserve.
- **Optimization-at-the-set-point procedure:**

The controller uses its instantaneous parameters for control to the set-point. In stable condition, the controller makes a pulse attempt. This pulse reduces the correcting variable by max. 20% ❶, to generate a slight process value undershoot. The changing process is analyzed and the parameters thus calculated are recorded in the controller. The optimized parameters are used for stabilized to the set-point.

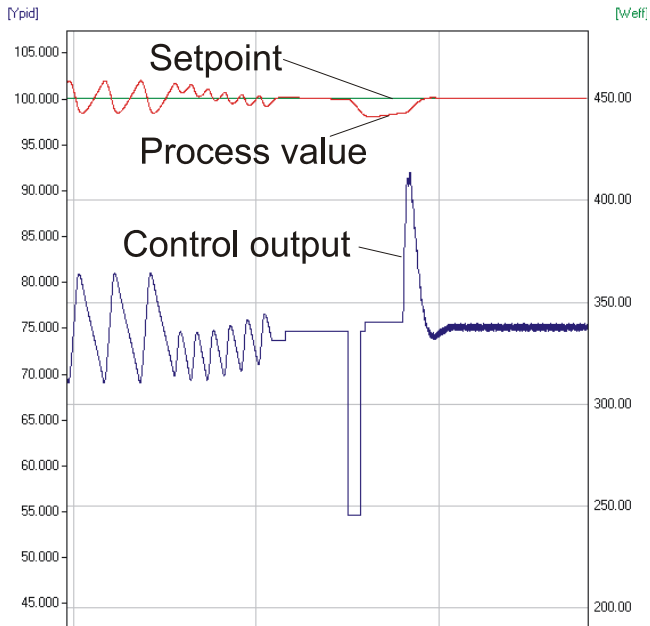

Optimization at the set-point

With a *3-point controller*, optimization for the "heating" or "cooling" parameters occurs dependent of the instantaneous condition.

While the controller is in the "heating-phase" the heating-parameters are determined. If the controller is in the "cooling-phase" the cooling-parameters are determined.

- ❶ If the correcting variable is too low for reduction in stable condition it is increased by max. 20%.

- **Optimization at the set-point for 3-point stepping controller**

As position feedback is not provided, the controller calculates the actuator position internally by adjusting an integrator with the adjusted actuator travel time.

For this reason, precise entry of the actuator travel time (t_t), as time between stops is highly important.

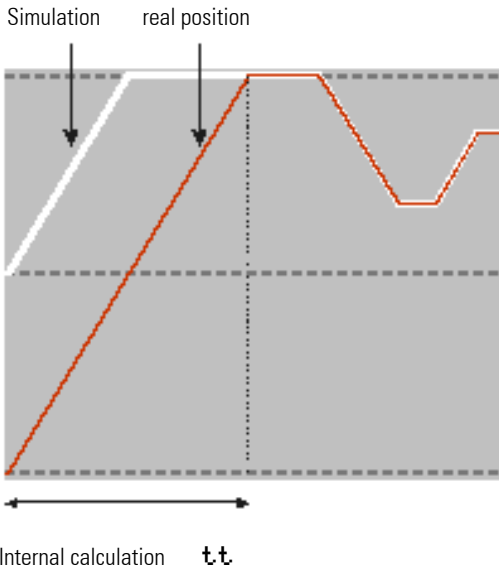

Due to position simulation, the controller knows whether an increased or reduced pulse must be output. After supply voltage switch-on, position simulation is at 50%. When the motor actuator was varied by the adjusted travel time in one go, internal calculation occurs, i.e. the position corresponds to the simulation:



Internal calculation always occurs, when the actuator was varied by travel time $t.t.$ *in one go*, independent of manual or automatic mode. When interrupting the variation, internal calculation is cancelled. Unless internal calculation occurred already after self-tuning start, it will occur automatically by closing the actuator once.

Unless the positioning limits were reached within 10 hours, a significant deviation between simulation and actual position may have occurred. In this case, the controller would realize minor internal calculation, i.e. the actuator would be closed by 20 %, and re-opened by 20 % subsequently. As a result, the controller knows that there is a 20% reserve for the attempt.

3.7.7 Self-tuning start



The operator can start self-tuning at any time. For this, keys  and  must be pressed simultaneously. With blinking in the second row the active adaptation is displayed **Ad: PIR**. The controller outputs 0%, waits until the process is at rest and starts self-tuning: **Ad: StP**

The self-tuning attempt is started when the following prerequisite is met:

- The difference between process value ↔ set-point must be $\geq 10\%$ of the set-point range ($SP.Hi - SP.Lo$) (with inverse action: process value smaller than set-point, with direct action: process value higher than set-point).

After successful self-tuning, the AdA-LED is off and the controller continues operating with the new control parameters.

- **Self-tuning cancellation by the operator:**



Self-tuning can always be cancelled by the operator. For this, press  and  key simultaneously. The controller continues operating with the old parameters in automatic mode in the first case and in manual mode in the second case.

- **Self-tuning cancellation by the controller:**

An error detected during self-tuning means that the technical conditions prevent successful self-tuning.



In this case, self-tuning was cancelled by the controller. The controller switches off its outputs (controller output 0%), to avoid exceeding the setpoint.

The user has two possibilities to acknowledge a failed adaptation:

1. Press keys  and  simultaneously:
The controller continues controlling using the old parameters in automatic mode. The self-tuning error must be acknowledged in the error list.
2. Press key :
Display of error list at extended operating level. After acknowledgement of the error message, the controller continues control in automatic mode using the old parameters.

Cancellation causes: → page 13: "Error status"

- **Acknowledgement of failed self-tuning**

When pressing the  key, the controller switches over to correcting variable display (\updownarrow ...). After pressing the key again, the controller goes to the error list of the extended operating level. The error message can be acknowledged by switching the message to 0 using the  - or the  key.

After acknowledging the error message, the controller continues operating in the automatic mode, using the parameters valid prior to self-tuning start.

3.7.8 Examples for self-tuning attempts

(controller inverse, heating or heating/cooling)

Start: heating power switched on

Heating power Y is switched off (1). When the change of process value X was constant during one minute (2), the power is switched on (3).

At the reversal point, the self-tuning attempt is finished and the new parameter are used for controlling to set-point W.

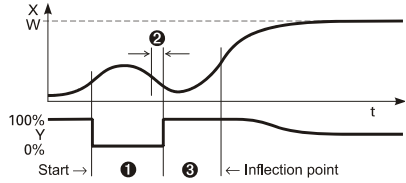

Start: heating power switched off

The controller waits 1,5 minutes (1). Heating power Y is switched on (2). At the reversal point, the self-tuning attempt is finished and control to the set-point is using the new parameters.

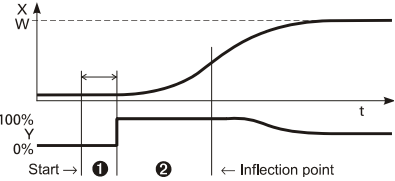

Self-tuning at the set-point ⚠

The process is controlled to the set-point. With the control deviation constant during a defined time (1), the controller outputs a reduced correcting variable pulse (max. 20%) (2). After determination of the control parameters using the process characteristic (3), control is started using the new parameters (4).

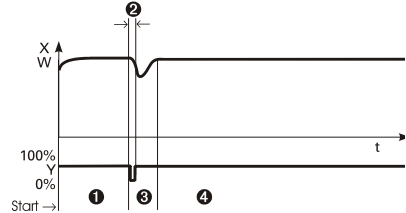

Three-point controller ⚠

The parameter for heating and cooling are determined in two attempts. The heating power is switched on (1). Heating parameters **Pb1**, **ti1**, **td1** and **t1** are determined at the reversal point. The process is controlled to the set-point (2). With constant control deviation, the controller provides a cooling correcting variable pulse (3). After determining its cooling parameters **Pb2**, **ti2**, **td2** and **t2** (4) from the process characteristics, control operation is started using the new parameters (5).

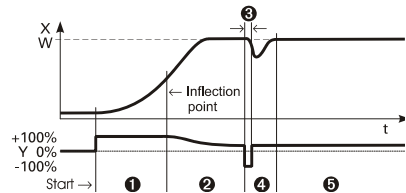



During phase ③, heating and cooling are done simultaneously!

3-point-stepping controller

After the start (①) the controller closes the actuator (② 0 u b t . 2). When the difference between process value and set-point is big enough (③), the changing of the process value is monitored for 1 min. (④). Afterwards the actuator is opened (⑤ 0 u b t . 1). If the reversal point is reached (⑥) or there are made enough measurements, the parameters are detected and are adopted.

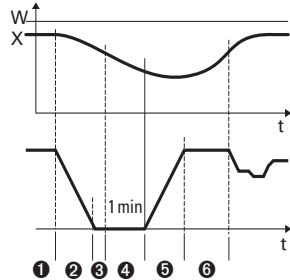

3.8 Help for manual tuning

The optimization aid should be used with units on which the control parameters shall be set without self-tuning.

For this, the response of process variable x after a step change of correcting variable y can be used. Frequently, plotting the complete response curve (0 to 100%) is not possible, because the process must be kept within defined limits.

Values T_g and x_{max} (step change from 0 to 100 %) or Δt and Δx (partial step response) can be used to determine the maximum rate of increase v_{max} .

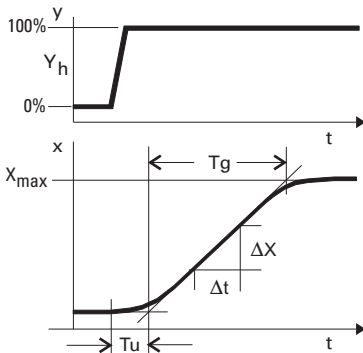

- y = correcting variable
- Y_h = control range
- T_u = delay time (s)
- T_g = recovery time (s)
- X_{max} = maximum process value

$$v_{max} = \frac{X_{max}}{T_g} = \frac{\Delta x}{\Delta t} \triangleq \max.$$

max. rate of increase of process value

The control parameters can be determined from the values calculated for delay time T_u , maximum rate of increase v_{max} , control range X_h and characteristic K according to the **formulas** given below. Increase P_b , if stabilized to the set-point oscillates.

Parameter adjustment effects

Parameter	Control	Stabilized of disturbances	Start-up behaviour
Pb1	higher	increased damping	slower stabilized
	lower	reduced damping	faster stabilized
td1	higher	reduced damping	faster response to disturbances
	lower	increased damping	slower response to disturbances
ti1	higher	increased damping	slower stabilized
	lower	reduced damping	faster stabilized
			slower reduction of duty cycle
			faster reduction of duty cycle

Formulas

$K = V_{max} * T_u$	controller behaviour	Pb [phys. units]	td [s]	ti [s]
With 2-point and 3-point controllers, the cycle time must be adjusted to $t_1 / t_2 \leq 0,25 * T_u$	PID	1,7 * K	2 * Tu	2 * Tu
	PD	0,5 * K	Tu	OFF
	PI	2,6 * K	OFF	6 * Tu
	P	K	OFF	OFF
	3-point-stepping	1,7 * K	Tu	2 * Tu

3.9 Second PID parameter set

The process characteristic is frequently affected by various factors such as process value, correcting variable and material differences.

To comply with these requirements, the controller can be switched over between two parameter sets. Parameter sets **PARA** and **PAR.2** are provided for heating and cooling.

Dependent of configuration, switch-over to the second parameter set (**CONF/LOG/Pid.2**) is via key **F**, one of digital inputs di1...di4 or interface (OPTION).



Self-tuning is always done using the active parameter set, i.e. the second parameter set must be active for optimizing.

3.10 Alarm handling

Max. three alarms can be configured and assigned to the individual outputs. Generally, outputs **Out. 1** ... **Out. 6** can be used each for alarm signalling. If more than one signal is linked to one output the signals are OR linked. Each of the 3 limit values **Lim. 1** ... **Lim. 3** has 2 trigger points **H. x** (Max) and **L. x** (Min), which can be switched off individually (parameter = "OFF"). Switching difference **HYS. x** of each limit value is adjustable.

① Operating principle absolute alarm

② Operating principle relative alarm

L. 1 = OFF

L. 1 = OFF

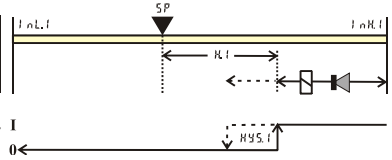
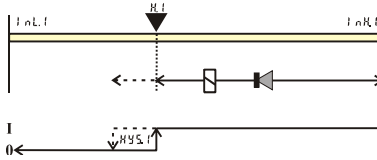

H. 1 = OFF

H. 1 = OFF

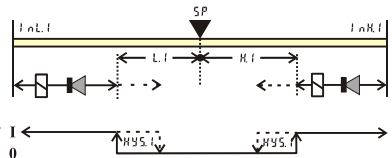
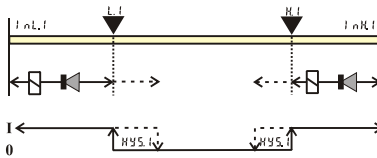
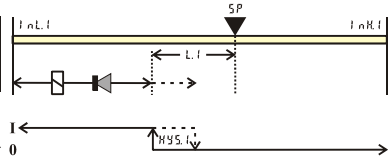
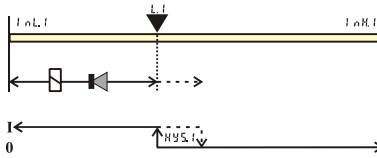

Normally open: See examples (**Conf / Out. x / O. Act = 0**)

Normally closed: The output relay action is inverted (**Conf / Out. x / O. Act = 1**)

The alarm LED always shows the threshold violation on (out of limits, switching point). If several alarms are used can be checked at the operating level, which alarm is active

(**☐** ... → **Lim. 1** **☐** ... **Lim. 3**)



The variable to be monitored can be selected separately per configuration for each alarm.

The following variables are available (**ConF / Lim / Src .x**):

Variable (Src .x)	Remark	Alarm type
Process value		Absolute
Control deviation xw	Process value - effective set-point. The effective set-point W_{eff} is used. E.g with a ramp, this is the changing set-point rather than the target set-point.	Relative
Control deviation xw + suppression after start-up or set-point change with time limit	The alarm output is suppressed after switch-on or after a set-point change, until the process value is within the limits for the first time. At the latest after elapse of time $10 \times t_{i1}$ the alarm is activated (t_{i1} = integral time 1; parameter → Contr). If t_{i1} is switched off (t_{i1} = OFF), this is considered as $\hat{1}$, i.e. the alarm is not activated before the process value was within the limits once.	Relative
Effective set-point W_{eff}	The effective set-point W_{eff} for control.	Absolute
Correcting variable y	y = controller output signal	Absolute
Deviation from SP internal	Process value - internal set-point. The internal set-point is used. E.g. with a ramp, this is the target set-point instead of the varying effective set-point W_{eff} .	Relative
Control deviation xw + suppression after start-up or set-point change without time limit	After switch-on or after a set-point change, the alarm output is suppressed , until the process value is within the limits for the first time.	Relative



During alarm configuration, the following functions can be selected (**ConF / Lim / Fnc .x**):



Function (Fnc .x)	Remark
Switched off	No limit value monitoring.
Measured value	Process value monitoring. When exceeding the limit, an alarm is generated. The alarm is reset automatically, when the process value is "within the limits" (including hysteresis) again.
Measured value + latch	Process value monitoring + latching of the alarm condition. When exceeding the limit value, an alarm is output. A latched alarm persists, until it is reset manually.

4. Configuration level



4.1 Configuration overview

ConF Configuration level	
<div style="display: flex; align-items: center; justify-content: center;"> ⏪ ⏩ </div> <div style="display: flex; align-items: center; justify-content: center; margin-top: 10px;"> ⏪ ⏩ </div>	Ctrl. Control and self-tuning Prog Programmer Imp.1 Input 1 Imp.2 Input 2 Lim Limit value functions Out.1 Output 1 Out.2 Output 2 Out.3 Output 3 Out.4 Output 4 Out.5 Output 5 Out.6 Output 6 Loai Digital inputs Opt.r Display, operation, interface End Quit
	SP.Fnc t.bAS StVP S.Lin Corr Fnc.1 Src.1 Fnc.2 Src.2 Fnc.3 Src.3 HC.AL LP.AL LP.AL HC.AL HC.SC TimE t.End P.End FAi.1 FAi.2 PrG.1 PrG2 PrG3 PrG4 CALL Out.0 Out.1 D.Src
	StVP I.Fnc Fnc.1 O.tVP O.Act V.1 V.2 Lim.1 Lim.2 Lim.2 Lim.3 LP.AL LP.AL HC.SC TimE t.End P.End FAi.1 FAi.2 PrG.1 PrG2 PrG3 PrG4 CALL
	See output 2 See output 2 See output 1 See output 2
	Lr bAud SP.2 Addr SP.E PrtV V.2 dELY g.E Unit mAn dP C.oFF Led Err.r C.dEl boos Pid.2 P.run P.oFF di.Fn

Adjustment:

- To access the configuration level, press the key  for 3 seconds and then the key  to select the ConF-Menu item. Press  to confirm.



- If the password function is activated, a prompt for **PASS** is displayed.
- The configuration values can be adjusted using the   keys. Press the  key to save the value. The next configuration value is shown.
- After the last configuration value of a group, **donE** is displayed, followed by automatic changing to the next group



Return to the beginning of a group, by pressing the  key for 3 sec



Press menu item **quit** to close/cancel configuration

4.2 Configurations

Confr

Name	Value range	Description	Default
SP.Fnc		Basic configuration of setpoint processing	0
	0	set-point controller can be switched over to external set-point (->LOGI / SP.E)	
	1	program controller	
	2	timer, mode 1 (bandwidth-controlled, switched off at the end)	
	3	timer, mode 2 (bandwidth-controlled, set-point remains active at the end)	
	4	timer, mode 3 (switched off at the end)	
	5	timer, mode 4 (set-point remains active at the end)	
	6	timer, mode 5 (switch-on delay)	
	7	timer, mode 6 (set-point switch-over)	
	10	controller with start-up circuit (see page 71)	
	11	Fixpoint / SP.E / SP.2 controller with start-up circuit (see page 71)	
b.ti	0...9999	Timer tolerance band	5
C.Fnc		Control behaviour (algorithm)	1
	0	on/off controller or signaller with one output	
	1	PID controller (2-point and continuous)	

Configuration level

	2	Δ / Y / Off, or 2-point controller with partial/full load switch-over	
	3	2 x PID (3-point and continuous)	
	4	3-point stepping controller	
mAn		Manual operation permitted	0
	0	no	
	1	yes (see also LOGI / mAn)	
C. Act		Method of controller operation	0
	0	inverse, e.g. heating With decreasing process value, the correcting variable is increased, <input type="checkbox"/> with increasing process value, the correcting variable is reduced.	
	1	direct, e.g. cooling With increasing process value, the correcting variable is increased, <input type="checkbox"/> with decreasing process value, the correcting variable is decreased	
FAIL		Behaviour at sensor break	1
	0	controller outputs switched off	
	1	$y = YZ$	
	2	$y = \text{mean output}$. In the event of a failure of the input signal, the mean value of the correcting variable output last is kept. The maximum permissible output can be adjusted with parameter Ym.H . To prevent determination of inadmissible values, mean value formation is only if the control deviation is lower than parameter L.Ym .	
	3	$y = \text{mean output}$; manual adjustment is possible. In the event of a failure of the input signal, the mean value of the correcting variable output last is kept. The maximum permissible output can be adjusted using parameter Ym.H . The mean output is measured at intervals of 1 min., when the control deviation is smaller than parameter L.Ym .	
rng.L	-1999...9999	X0 (lower limit of control range) indicates the smallest value to be expected as process value.	-100
rng.H	-1999...9999	X100 (high limit range of control) indicates the highest value to be expected as process value.	1200
SP2C		With active SP.2 no cooling controlling is provided	0
	0	standard (cooling permissible with all set-points)	
	1	no cooling provided with active SP.2	
CYCL		Characteristic for 2-point- and 3-point-controllers	0
	0	Standard (see page 42)	
	1	water cooling linear (see page 43)	
	2	water cooling non-linear (see page 44)	
	3	with constant cycle (see page 45)	

Configuration level

tuneE		Auto-tuning at start-up	0
	0	At start-up with step function	
	1	At start-up with impulse function. Setting for fast controlled systems (e.g. hot runner control)	
	2	Always step attempt during start-up	
Start		Start of auto-tuning	0
	0	no automatic start (manual start via front interface)	
	1	Manual or automatic start of auto-tuning at power on or when oscillating is detected	
Adt0		Optimization of T1, T2 (only visible with BlueControl!)	0
	0	Automatic optimization	
	1	No optimization	

Prog

Name	Value range	Description	Default
t.bAS		Time base	0
	0	hours:minutes	
	1	minutes:seconds	

InP.1

Name	Value range	Description	Default
S.tYP		Sensor type selection	1
	0	thermocouple type L (-100...900°C), Fe-CuNi DIN	
	1	thermocouple type J (-100...1200°C), Fe-CuNi	
	2	thermocouple type K (-100...1350°C), NiCr-Ni	
	3	thermocouple type N (-100...1300°C), Nicrosil-Nisil	
	4	thermocouple type S (0...1760°C), PtRh-Pt10%	
	5	thermocouple type R (0...1760°C), PtRh-Pt13%	
	6	thermocouple type T (-200...400°C), Cu-NiCu	
	7	thermocouple type C (0...2315°C), W5%Re-W26%Re	
	8	thermocouple type D (0...2315°C), W3%Re-W25%Re	
	9	thermocouple type E (-100...1000°C), NiCr-CuNi	
	10	thermocouple type B (0/100...1820°C), PtRh-Pt6%	
	18	special thermocouple	
	20	Pt100 (-200.0 ... 100.0 °C) (-200,0 ... 150,0°C with reduced lead resistance: measuring resistance + lead resistance ≤ 160Ω)	
21	Pt100 (-200.0 ... 850.0 °C)		
22	Pt1000 (-200.0 ... 850.0 °C)		

Configuration level

	23	special 0...4500 Ohm (pre-defined as KTY11-6)	
	30	0...20mA / 4...20mA Scaling is required (see chp. □ page 57)	
	40	0...10V / 2...10V Scaling is required (see chp. □ page 57)	
S.Lin		Linearization (only at S.tYP = 23 (KTY 11-6), 30 (0..20mA) and 40 (0..10V) adjustable) (see page 74)	0
	0	Without linearization	
	1	Linearization to specification. Creation of linearization table with BlueControl (engineering tool) possible. The characteristic for KTY 11-6 temperature sensors is preset.	
Corr		Measured value correction / scaling	0
	0	Without scaling	
	1	Offset correction (at CAL level) (see page 58)	
	2	2-point correction (at CAL level 58)	
	3	Scaling (at PARa level) (see page 57)	
fAI1		Forcing INP1 (only visible with BlueControl®!)	0
	0	No forcing	
	1	Forcing via serial interface	

InP.2

Name	Value range	Description	Default
I.Fnc		Function selection of INP2	1
	0	no function (subsequent input data are skipped)	
	1	heating current input	
	2	external set-point (SP.E)	
	5	default correcting variable Y.E (switchover -> LOGI/Y.E)	
S.tYP		Sensor type selection	31
	30	0...20mA / 4...20mA Scaling is required (see chp. □ page 57)	
	31	0...50mA AC Scaling is required. (see chp. □ page 57)	
fAI2		Forcing INP2 (only visible with BlueControl®!)	0
	0	No forcing	
	1	Forcing via serial interface	

Lim

Name	Value range	Description	Default
Fnc.1		Function of limit 1/2/3	1
Fnc.2	0	switched off	
Fnc.3	1	measured value monitoring	
	2	Measured value monitoring + alarm status storage. A stored limit value can be reset via error list, [E]-key, or a digital input (->LOGI/Err.r)	
Src.1		Source of Limit 1/2/3	1
Src.2	0	process value	
Src.3	1	control deviation xw (process value - set-point)	
	2	control deviation xw (with suppression after start-up and set-point change)	
	6	effective setpoint Weff	
	7	correcting variable y (controller output)	
	8	control variable deviation xw (actual value - internal setpoint) = deviation alarm to internal setpoint	
	11	Control deviation Xw (=relative alarm) with suppression after start-up or set-point change without time limit.	
HC.AL		Alarm heat current function (INP2)	0
	0	switched off	
	1	Overload short circuit monitoring	
	2	Break and short circuit monitoring	
LP.AL		Monitoring of control loop interruption for heating	0
	0	switched off / inactive	
	1	LOOP alarm active. A loop alarm is output, unless the process value reacts accordingly after elapse of 2 xti1 with Y=100%. With ti1=0, the LOOP alarm is inactive!	
Hour	OFF..999999	Operating hours (only visible with BlueControl®!)	OFF
Swit	OFF..999999	Output switching cycles (only visible with BlueControl®!)	OFF

Out.1

Name	Value range	Description	Default
O.tYP		Signal type selection OUT1	0
	0	relay / logic (only visible with current/logic voltage)	
	1	0 ... 20 mA continuous (only visible with current/logic/voltage)	
	2	4 ... 20 mA continuous (only visible with current/logic/voltage)	
	3	0...10 V continuous (only visible with current/logic/voltage)	

Configuration level

	4	2...10 V continuous (only visible with current/logic/voltage)	
	5	transmitter supply (only visible without OPTION)	
O. Act		Method of operation of output OUT (only visible when O. TYP=0)	0
	0	direct / normally open	
	1	inverse / normally closed	
Y.1 Y.2		Controller output Y1/Y2 (only visible when O. TYP=0)	1
	0	not active	
	1	active	
Lim.1 Lim.2 Lim.3		Limit 1/2/3 signal (only visible when O. TYP=0)	0
	0	not active	
	1	active	
LP. AL		Interruption alarm signal (LOOP) (only visible when O. TYP=0)	0
	0	not active	
	1	active	
HC. AL		Heat current alarm signal (only visible when O. TYP=0)	0
	0	not active	
	1	active	
HC. SC		Solid state relay (SSR) short circuit signal (only visible when O. TYP=0)	0
	0	not active	
	1	active	
time		Timer active (only visible when O. TYP=0)	0
	0	not active	
	1	Active	
t. End		Timer End (only visible when O. TYP=0)	0
	0	not active	
	1	active	
P. End		Programmer end signal (only visible when O. TYP=0)	0
	0	not active	
	1	active	
FAi.1 FAi.2		INP1/ INP2 error signal (only visible when O. TYP=0)	0
	0	not active	
	1	active	
PrG.1 PrG.2 PrG.3 PrG.4		Program track 1 to 4 (only visible when O. TYP=0)	0
	0	not active	
	1	active	
CALL		Operator call (only visible when O. TYP=0)	0

Configuration level

	0	not active	
	1	active	
Out. 0	-1999...9999	Scaling of the analog output for 0% (0/4mA or 0/2V, only visible when O. TYP=1..5)	0
Out. 1	-1999...9999	Scaling of the analog output for 100% (20mA or 10V, only visible when O. TYP=1..5)	100
O. Src		Signal source of the analog output OUT3 (only visible when O. TYP=1..5)	1
	0	not used	
	1	controller output y1 (continuous)	
	2	controller output y2 (continuous)	
	3	process value	
	4	effective set-point Weff	
	5	control deviation xw (process value - set-point)	
	6	No function	
fOut		Forcing OUT1 (only visible with BlueControl!)	0
	0	No forcing	
	1	Forcing via serial interface	

Out. 3 Configuration parameters **Out. 2** as **Out. 1** except for: Default **Y. 1 = 0, Y. 2 = 1**

Out. 5 Configuration parameters **Out. 5** as **Out. 1** except for default values:
All values are 0!

Out. 2 / 4 / 6

Name	Value range	Description	Default
O. Act		Method of operation of output	1
	0	direct / normally open	
	1	inverse / normally closed	
Y. 1		Controller output Y1/Y2	0
Y. 2	0	not active	
	1	active	
Lim. 1		Limit 1/2/3 signal	1
Lim. 2	0	not active	
Lim. 3	1	active	
LP. AL		Interruption alarm signal (LOOP)	0
	0	not active	
	1	active	
HC. AL		Heating current alarm signal	0

	0	not active	
	1	active	
HC.SC		Solid state relay (SSR) short circuit signal (only visible when O.TYP=0)	0
	0	not active	
	1	active	
time		Timer active (only visible when O.TYP=0)	0
	0	not active	
	1	active	
t.End		Timer End (only visible when O.TYP=0)	0
	0	not active	
	1	active	
P.End		Programmer end signal (only visible when O.TYP=0)	0
	0	not active	
	1	active	
FAi.1		INP1/ INP2 error (only visible when O.TYP=0)	1
FAi.2	0	not active	
	1	active	
PrG.1		Program track 1 to 4 (only visible when O.TYP=0)	0
PrG.2	0	not active	
PrG.3	1	active	
PrG.4			
CALL		Operator call (only visible when O.TYP=0)	0
	0	not active	
	1	active	
fOut		Forcing OUT3 (only visible with BlueControl!)	0
	0	No forcing	
	1	Forcing via serial interface	

Out.4 / Out.6

Configuration parameters as **Out.1** except for: Default $Y.1 = 0$, $Y.2 = 0$



Method of operation and usage of output **Out.1** to **Out.6**:

Is more than one signal chosen active as source, those signals are OR-linked.

LOGI

Name	Value range	Description	Default
L.R		Local / Remote switching (Remote: adjusting of all values by front keys is blocked)	0
	0	no function (switch-over via interface is possible)	
	1	active	
	2	DI1	
	3	Di 2	
	4	DI3 (only visible with OPTION)	
	5	DI4 (only visible with OPTION)	
	6	F -Key function (see chapter 3.6 page 14)	
	7	Limit 1	
	8	Limit 2	
	9	Limit 3	
SP.2		Switching to second setpoint SP.2	0
	0	no function (switch-over via interface is possible)	
	2	DI1	
	3	Di 2	
	4	DI3 (only visible with OPTION)	
	5	DI4 (only visible with OPTION)	
	6	F -Key function (see chapter 3.6 page 14)	
	7	Limit 1	
	8	Limit 2	
	9	Limit 3	
	SP.E		Switching to external setpoint SP.E
0		no function (switch-over via interface is possible)	
1		active	
2		DI1	
3		Di 2	
4		DI3 (only visible with OPTION)	
5		DI4 (only visible with OPTION)	
6		F -Key function (see chapter 3.6 page 14)	
7		Limit 1	
8		Limit 2	
9		Limit 3	
Y2		Y/Y2 switching	0
	0	no function (switch-over via interface is possible)	
	2	DI1	

Configuration level

	3	Di 2	
	4	DI3 (only visible with OPTION)	
	5	DI4 (only visible with OPTION)	
	6	F -Key function (see chapter 3.6 page 14)	
	7	Limit 1	
	8	Limit 2	
	9	Limit 3	
YE		YE switch-over	0
	0	No function (switch-over via interface is possible)	
	1	always active	
	2	DI1 switches	
	3	Di 2	
	4	DI3 (only visible with OPTION)	
	5	DI4 (only visible with OPTION)	
	6	F -Key function (see chapter 3.6 page 14)	
	7	Limit 1	
	8	Limit 2	
mAn		Automatic/manual switching	0
	0	no function (switch-over via interface is possible)	
	1	always activated (manual station)	
	2	DI1	
	3	Di 2	
	4	DI3 (only visible with OPTION)	
	5	DI4 (only visible with OPTION)	
	6	F -Key function (see chapter 3.6 page 14)	
	7	Limit 1	
	8	Limit 2	
C. off		Switching off the controller	0
	0	no function (switch-over via interface is possible)	
	2	DI1	
	3	Di 2	
	4	DI3 (only visible with OPTION)	
	5	DI4 (only visible with OPTION)	
	6	F -Key function (see chapter 3.6 page 14)	
	7	Limit 1	

Configuration level

	8	Limit 2	
	9	Limit 3	
Err.r		Reset of all error list entries	0
	0	no function (switch-over via interface is possible)	
	2	DI1	
	3	Di 2	
	4	DI3 (only visible with OPTION)	
	5	DI4 (only visible with OPTION)	
	6	F -Key function (see chapter 3.6 page 14)	
	7	Limit 1	
	8	Limit 2	
	9	Limit 3	
booS		Boost function: setpoint increases by SP.bo for the time t.bo	0
	0	no function (switch-over via interface is possible)	
	2	DI1	
	3	Di 2	
	4	DI3 (only visible with OPTION)	
	5	DI4 (only visible with OPTION)	
	6	F -Key function (see chapter 3.6 page 14)	
	7	Limit 1	
	8	Limit 2	
	9	Limit 3	
Pid.2		Switching of parameter set (Pb, ti, td)	0
	0	no function (switch-over via interface is possible)	
	2	DI1	
	3	Di 2	
	4	DI3 (only visible with OPTION)	
	5	DI4 (only visible with OPTION)	
	6	F -Key function (see chapter 3.6 page 14)	
	7	Limit 1	
	8	Limit 2	
	9	Limit 3	
P.run		Programmer Run/Stop (see page)	0
	0	no function (switch-over via interface is possible)	
	2	DI1	
	3	Di 2	
	4	DI3 (only visible with OPTION)	
	5	DI4 (only visible with OPTION)	

Configuration level

	6	<input type="checkbox"/> -Key function (see chapter 3.6 page 14)	
	7	Limit 1	
	8	Limit 2	
	9	Limit 3	
P.oFF		Programmer Run/Stop (see page)	0
	0	no function (switch-over via interface is possible)	
	2	DI1	
	3	DI 2	
	4	DI3 (only visible with OPTION)	
	5	DI4 (only visible with OPTION)	
	6	<input type="checkbox"/> -Key function (see chapter 3.6 page 14)	
	7	Limit 1	
	8	Limit 2	
	9	Limit 3	
di.Fn		Function of digital inputs (valid for all inputs)	0
	0	direct	
	1	inverse	
	2	toggle key function	
fDI1 fDI2 fDI3 fDI4		Forcing di1/ di2 / di3 (only visible with BlueControl!)	0
	0	No forcing	
	1	Forcing via serial interface	

othr

Name	Value range	Description	Default
bAud		Baudrate of the interface (only visible with OPTION)	2
	0	2400 Baud	
	1	4800 Baud	
	2	9600 Baud	
	3	19200 Baud	
Addr	1...247	Address on the interace (only visible with OPTION)	1
PrtV		Data parity on the interface (only visible with OPTION)	1
	0	no parity (2 stop bits)	
	1	even parity	
	2	odd parity	
dELY	0...200	Delay of response signal [ms] (only visible with OPTION)	0
Unit		Unit	1
	0	without unit	

Configuration level

	1	°C	
	2	°F	
dP		Decimal point (max. number of digits behind the decimal point)	0
	0	no digit behind the decimal point	
	1	1 digit behind the decimal point	
	2	2 digits behind the decimal point	
	3	3 digits behind the decimal point	
C.dE1	0..200	Modem delay [ms] Additional delay time before the received message is evaluated in Modbus. This time is needed by the modem if messages are not transferred continuously.	0
FrE4		Switching 50 Hz / 60 Hz (only visible with BlueControl®!)	0
	0	50 Hz	
	1	60 Hz	
MASt		Modbus Master / Slave (only visible with BlueControl®!)	0
	0	No	
	1	Yes	
Cycl	0 ... 240	Mastercycle (sec.) (only visible with BlueControl®!)	120
AdrØ	-32768 ... 32767	Destination address (only visible with BlueControl®!)	1100
AdrU	-32768 ... 32767	Source address (only visible with BlueControl®!)	1100
Numb	0 ... 100	Number of data (only visible with BlueControl®!)	1
ICof		Block controller off (only visible with BlueControl®!)	0
	0	Released	
	1	Blocked	
IAda		Block auto tuning (only visible with BlueControl®!)	0
	0	Released	
	1	Blocked	
IExo		Block extended operating level (only visible with BlueControl®!)	0
	0	Released	
	1	Blocked	
ILat		Suppression error storage (only visible with BlueControl®!)	0
	0	No	
	1	Yes	
PTMP		Access temporary program changes (only visible with BlueControl®!)	0
	0	No	
	1	Yes	

Configuration level

FPre		Access preset to end and reset (only visible with BlueControl®!)	0
	0	No	
	1	Yes	
FRun		Access run / stop (only visible with BlueControl®!)	0
	0	No	
	1	Yes	
FCom		Access common program parameters (only visible with BlueControl®!)	0
	0	No	
	1	Yes	
Pass	OFF...9999	Password (only visible with BlueControl®!)	OFF
IPar		Block parameter level (only visible with BlueControl®!)	1
	0	Released	
	1	Blocked	
ICnf		Block configuration level (only visible with BlueControl®!)	1
	0	Released	
	1	Block	
ICal		Block calibration level (only visible with BlueControl®!)	1
	0	Released	
	1	Blocked	
F.Coff		Switch-off behaviour (only visible with BlueControl®!)	0
	0	PID - controller functions off	
	1	All functions off	
D2.Err		Error displayed in display 2 (only visible with BlueControl®!)	0
	0	No reaction to errors	
	1	Blinking error display	
PDis3		display 3 programmer operation (only visible with BlueControl®!)	0
	0	Segment no., Segment type, remaining prog time	
	1	Segment no., Segment type, remaining segm time	
	2	Segment no., Segment type, total time	
	3	Program no., Segment type, remaining prog time	
	4	Program no., Segment type, remaining segm time	
	5	Program no., Segment type, total time	



Resetting the controller configuration to factory setting (Default
→ chapter 13.1 (page 86))

BlueControl - the engineering tool for the BluePort® controller series

For facilitating configuration and parameter setting of the KS20-1 an engineering tool with different functionality levels is available : Accessory equipment with ordering information.



In addition to configuration and parameter setting, BlueControl® is used for data acquisition and offers long-term storage and print functions. BlueControl® is connected to KS20-1 via the program interface "BluePort®" by means of PC (Windows XP / Vista / Windows7 / Windows8) and a PC adapter.

Description BlueControl®: see chapter : BlueControl (page 79)

4.3 Set-point processing

The set-point processing structure is shown in the following picture:

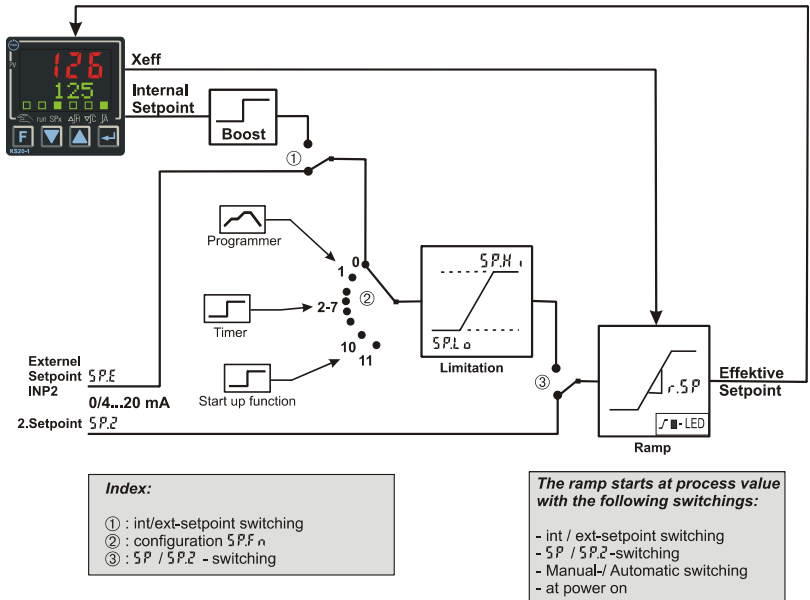

4.3.1 Set-point gradient / ramp

To prevent set-point step changes, parameter \rightarrow set-point $\rightarrow r.SP$ can be adjusted to a maximum rate of change. This gradient is effective in positive and negative direction..

With parameter $r.SP$ set to **OFF** (default), the gradient is switched off and set-point changes are realized directly.

(for parameter: see page 55)

4.3.2 Cooling functions

The configuration parameter **CYCL (Conf/Cntr/CYCL)** can be used for matching the cycle time of 2-point and 3-point controllers. This can be done using the following 4 methods.

4.3.3 Standard ($CyCl=0$)

The adjusted cycle times $t1$ and $t2$ are valid for 50% or -50% correcting variable. With very small or very high values, the effective cycle time is extended to prevent unreasonably

short on and off pulses. The shortest pulses result from $\frac{1}{4} \times t_1$ or $\frac{1}{4} \times t_2$. The characteristic curve is also called "bath tub curve".

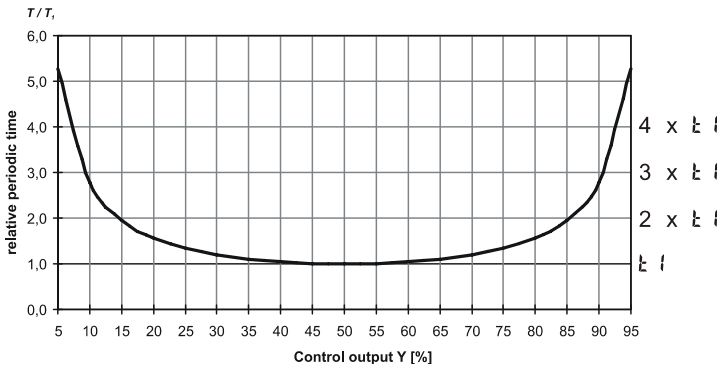

Parameters to be adjusted **t₁** : min. cycle time 1 (heating) [s]
 (PARA/Cntr) **t₂** : min. cycle time 2 (cooling) [s]

4.3.4 Switching attitude linear (CyC1=1)

For heating (Y1), the standard method (see chapter 4.3.3) is used. For cooling (Y2), a special algorithm for cooling with water is used.

Generally, cooling is enabled only at an adjustable process temperature (E.H2O), because low temperatures prevent evaporation with related cooling, whereby damage to the plant is avoided. The cooling pulse length is adjustable using parameter **t.on** and is fixed for all output values.

The "off" time is varied dependent of output value. Parameter **t.off** is used for determining the min "off" time. For output of a shorter off pulse, this pulse is suppressed, i.e. the max. effective cooling output value is calculated according to formula $t.on / (t.on + t.off) \times 100\%$.

Parameters to be adjusted: **E.H2O**: minimum temperature for water cooling
 (PARA / Cntr) **t.on**: pulse duration water cooling
t.off: minimum pause water cooling

4.3.5 Switching attitude non-linear (C₉C1= 2)

With this method, the cooling power is normally much higher than the heating power, i.e. the effect on the behaviour during transition from heating to cooling may be negative. The cooling curve ensures that the control intervention with 0 to -70% correcting variable is very weak. Moreover, the correcting variable increases very quickly to max. possible cooling. Parameter **F.H2O** can be used for changing the characteristic curve. The standard method (see section 4.3.3) is also used for heating. Cooling is also enabled dependent of process temperature .

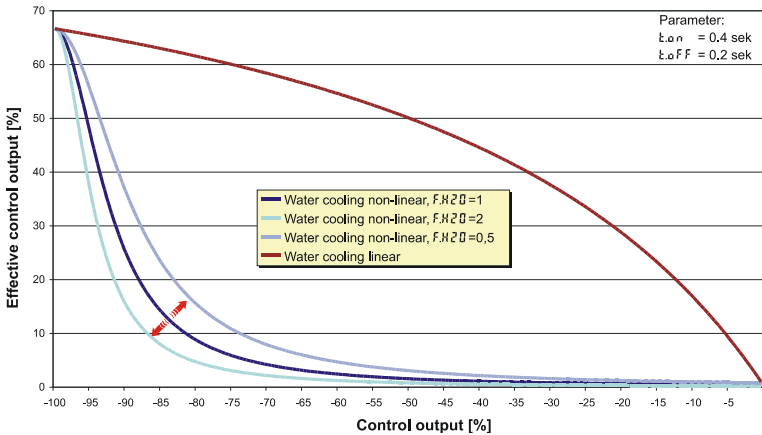
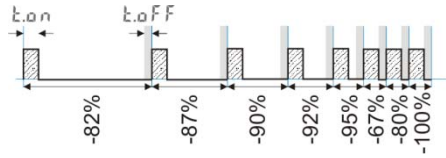

- Parameters to be adjusted (PARA / Cntr)
- E. H2O**: min. temperature for water cooling
 - t.on**: Pulse duration water cooling
 - t.off**: min. pause water cooling
 - F. H2O**: adaptation of (non-linear) characteristic Water cooling

4.3.6 Heating and cooling with constant period (**CyC1=3**)

The adjusted cycle times **t1** and **t2** are met in the overall output range. To prevent unreasonably short pulses, parameter **tp** is used for adjusting the shortest pulse duration. With small correcting values which require a pulse shorter than the value adjusted in **tp**, this pulse is suppressed. However, the controller stores the pulse and totalizes further pulses, until a pulse of duration **tp** can be output.

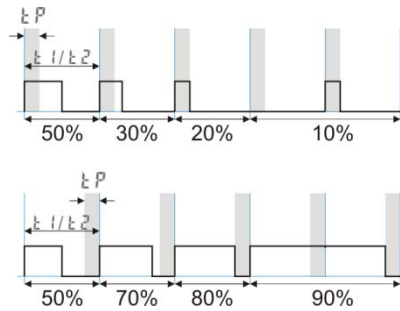

Parameters to be adjusted **t1** : Min. cycle time 1 (heating) [s]
(PARA/Cntr) **t2** : min. cycle time 2 (cooling) [s]
tP : min. pulse length [s]

4.4 Configuration examples

4.4.1 On-Off controller / Signaller (inverse)

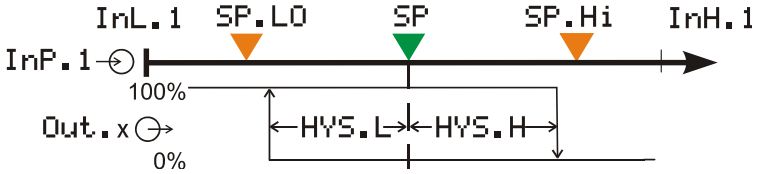

ConF/Cntr:	SP.Fn = 0	set-point /cascade controller
	C.Fnc = 0	signaller with one output
	C.Act = 0	inverse output action (e.g. heating applications)
ConF/Out.1:	O.Act = 0	output action Out.1 direct
	Y.1 = 1	control output Y1 active
PARA/Cntr:	HYS.L = 0...9999	switching difference below SP
PARA/Cntr:	HYS.H = 0...9999	switching difference above SP
PARA/SEtP:	SP.LO = -1999...9999	lower set-point limit for Weff
	SP.Hi = -1999...9999	upper set-point limit for Weff



For direct signaller action, the controller action must be changed (ConF / Cntr / C.Act = 1)

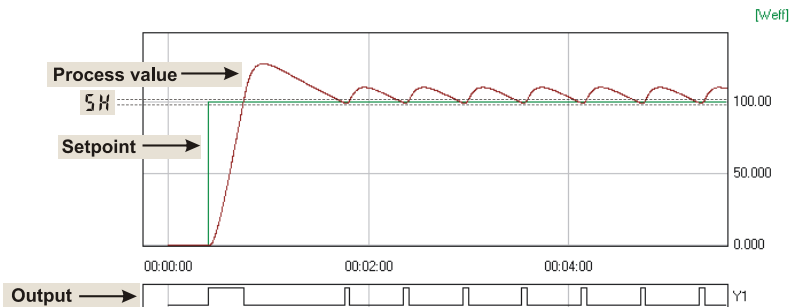

4.4.2 2-point and continuous controller (inverse)

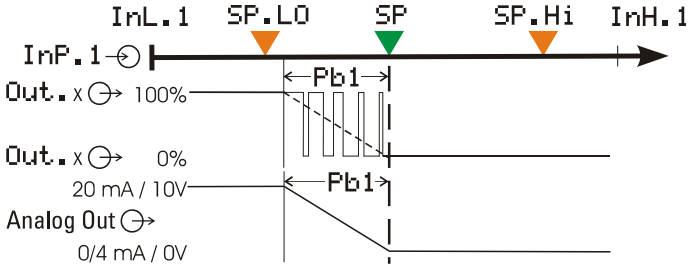

ConF/Cntr	SP.Fn = 0	set-point / cascade controller
	C.Fnc = 1	2-point and continuous controller (PID)
	C.Act = 0	inverse action (e.g. heating applications)
ConF/Out.1:	O.Act = 0	action Out.1 direct
	Y.1 = 1	control output Y1 active
ConF/Out.3:	O.tYP = 1 / 2	Out.3 Type (0/4 ... 20mA)
	Out.0 = -1999...9999	scaling analog output 0/4mA
	Out.1 = -1999...9999	scaling analog output 20mA
	O.Src = 1	controller output y1 (continuous)
PARA/Cntr:	Pb1 = 1...9999	proportional band 1 (heating) in units of phys. quantity (e.g. °C)
	ti1 = 0,1...9999	integral time 1 (heating) in sec.
	td1 = 0,1...9999	derivative time 1 (heating) in sec.
	t1 = 0,4...9999	min. cycle time 1 (heating)
PARA/SEtP:	SP.LO = -1999...999	set-point limit low for Weff
	SP.Hi = -1999...9999	set-point limit high for Weff



For direct controller action, the controller action must be changed (ConF / Cntr / C.Act = 1)

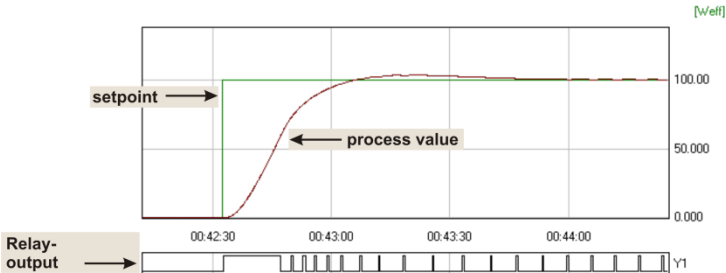

4.4.3 3-point and continuous controller

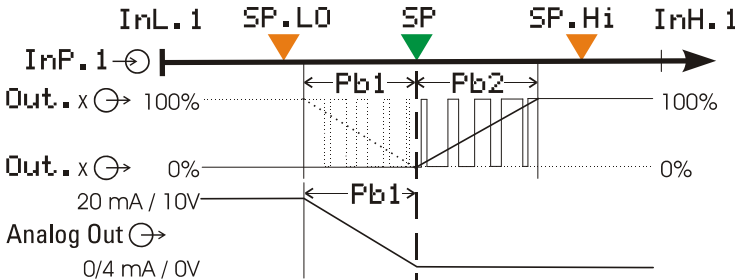

ConF/Cntr:	SP.Fn = 0	set-point / cascade controller
	C.Fnc = 3	3-point controller (2xPID)
	C.Act = 0	action inverse (e.g. heating applications)
ConF/Out.1:	O.Act = 0	action Out.1 direct
	Y.1 = 1	control output Y1 active
	Y.2 = 0	control output Y2 not active
ConF/Out.2:	O.Act = 0	action Out.2 direct
	Y.1 = 0	control output Y1 not active
	Y.2 = 1	control output Y2 active
ConF/Out.3:	O.typ = 1 / 2	0 ... 20 mA continuous. / 4 ... 20 mA
	Out.0 = 0	scaling 0 %
	Out.1 = 100	scaling 100 %
	O.Src = 1	controller output y1 (continuous)
PARA/Cntr:	Pb1 = 1...9999	proportional band 1 (heating) in units of phys. quantity (e.g. °C)
	Pb2 = 1...9999	proportional band 2 (cooling) in units of phys. quantity (e.g. °C)
	ti1 = 0,1...9999	integral time 1 (heating) in sec.
	ti2 = 0,1...9999	derivative time 2 (cooling) in sec.
	td1 = 0,1...9999	integral time 1 (heating) in sec.
	td2 = 0,1...9999	derivative time 2 (cooling) in sec.
	t1 = 0,4...9999	min. cycle time 1 (heating)
	t2 = 0,4...9999	min. cycle time 2 (cooling)
	SH = 0...9999	neutr. zone in units of phys.quantity
PARA/SEtP:	SP.0 = -1999...9999	set-point limit low for Weff
	SP.Hi = -1999...9999	set-point limit high for Weff

4.4.4 3-point stepping controller (relay & relay)

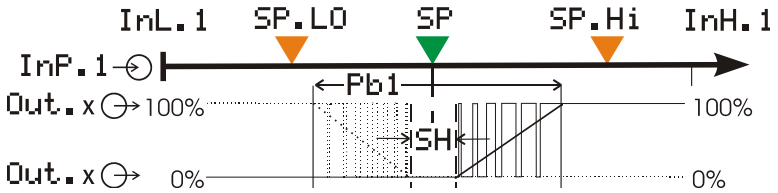

ConF/Cntr:	SP.Fn = 0	set-point / cascade controller
	C.Fnc = 4	3-point stepping controller inverse action (e.g. heating applications)
	C.Act = 0	action Out.1 direct
ConF/Out.1:	O.Act = 0	control output Y1 active
	Y.1 = 1	control output Y2 not active
	Y.2 = 0	action Out.2 direct
ConF/Out.2:	O.Act = 0	control output Y1 not active
	Y.1 = 0	control output Y2 active
	Y.2 = 1	proportional band 1 (heating) in units of phys. quantity (e.g. °C)
PARA/Cntr:	Pb1 = 1...9999	integral time 1 (heating) in sec.
	ti1 = 0,1...9999	derivative time 1 (heating) in sec.
	td1 = 0,1...9999	min. cycle time 1 (heating)
	t1 = 0,4...9999	neutral zone in units of phy. quantity
	SH = 0...9999	min. pulse length in sec.
	tP = 0,1...9999	actuator travel time in sec.
	tt = 3...9999	set-point limit low for Weff
PARA/SEtP:	SP.LO = -1999...9999	set-point limit high for Weff
	SP.Hi = -1999...9999	set-point / cascade controller



For direct action of the 3-point stepping controller, the controller output action must be changed (**ConF / Cntr / C.Act = 1**)

4.4.5 Δ - Y - Off controller / 2-point controller with pre-contact

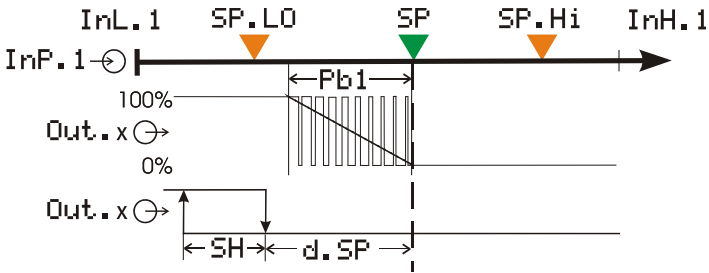

ConF/Cntr:	SP.Fn = 0	set-point / cascade controller
	C.Fnc = 2	D - Y - Off controller
	C.Act = 0	inverse action (e.g. heating applications)
ConF/Out.1:	O.Act = 0	action Out.1 direct
	Y.1 = 1	control output Y1 active
	Y.2 = 0	control output Y2 not active
ConF/Out.2:	O.Act = 0	action Out.2 direct
	Y.1 = 0	control output Y1 not active
	Y.2 = 1	control output Y2 active
PARA/Cntr:	Pb1 = 1...9999	proportional band 1 (heating) in units of phys. quantity (e.g. °C)
	ti1 = 0,1...9999	integral time 1 (heating) in sec.
	td1 = 0,1...9999	derivative time 1 (heating) in sec.
	t1 = 0,4...9999	min. cycle time 1 (heating)
	SH = 0...9999	switching difference
	d.SP = -1999...9999	trigg. point separation suppl. cont.
PARA/SEtP:	SP.LO = -1999...9999	D / Y / Off in units of phys. quantity
	SP.Hi = -1999...9999	set-point limit low for Weff

4.4.6 KS 20-1 with measured value output

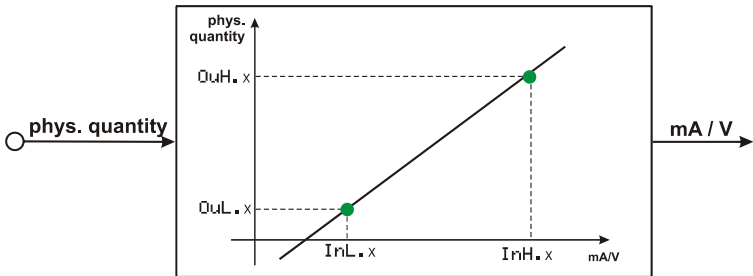

Example: KS20-10H-LR000-000

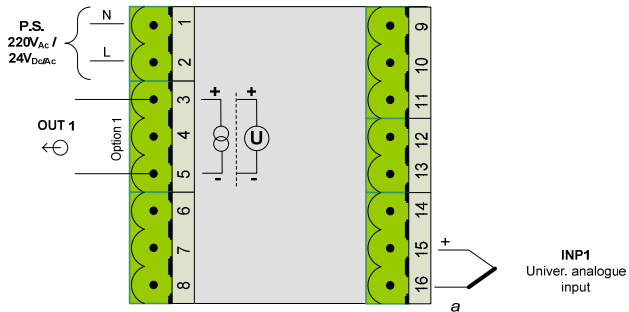



ConF/Out.3:0.tYP	= 1	Out.3	0...20mA continuous
	= 2	Out.3	4...20mA continuous
	= 3	Out.3	0...10V continuous
	= 4	Out.3	2...10V continuous
	Out.0 = -1999...9999	Scaling	Out.3 for 0/4mA e.g. 0/2V
	Out.1 = -1999...9999	Scaling	Out.3 for 20mA e.g. 10V
	0.Src = 3	Signal source for	Out.3 is the process value

5. Parameter-Level



5.1 Parameter-Overview

PARA Parameter level								
	Ctrl Control and self-tuning	PAR. 2 2. set of parameters	SEtP Set-point and process value	INP. 1 Input 1	INP. 2 Input 2	LIm <input type="checkbox"/> Limit value functions	PRoG Programmer	End
		Pb1	Pb12	SP.Lo	InL.1	In1.2	L.1	Pr.no
	Pb2	Pb22	SP.Hi	0uL.1	0uL.2	H.1		
	ti1	ti12	SP.2	InH.1	InH.2	HVS.1		
	ti2	ti22	r.SP	0uH.1	0uH.2	dE1.1		
	td1	td12	t.SP	tF.1		L.2		
	td2	td22	SP.bo			H.2		
	t1		t.bo			HVS.2		
	t2		v.St			dE1.2		
	SH		SP.St			L.3		
	Hys.1		t.St			H.3		
	Hys.H					HVS.3		
	d.SP					dE1.3		
	tP					HC.A		
	tt							
	Y2							
	Y.Lo							
	Y.Hi							
	Y0							
	Ym.H							
	L.Ym							
	E.H20							
	t.on							
	t.off							
	FH2o							

Adjustment:

To access the parameter level, press the key  for 3 seconds and confirm using the -key subsequently. If the password function is activated, the prompt for the **PASS** is displayed



- The parameters can be adjusted using the  - keys.
- Press the  - key to change to the next parameter.
- After the last parameter of a group, **done** is displayed and followed by automatic changing to the next group



Return to the beginning of a group, by pressing the  key for 3 sec.





Unless a key is pressed during 30 seconds, the controller returns to the process value and setpoint display (Time Out = 30 sec.)



Resetting the configuration parameters to default
→ chapter 86 (page 86)

5.2 Parameter

Cntr

Name	Value range	Description	Default
Pb1	1...9999 	Proportional band 1 (heating) in phys. dimensions (e.g. °C)	100
Pb2	1...9999 	Proportional band 2 (cooling) in phys. dimensions (e.g. °C)	100
ti1	OFF/0,1...9999	Integral action time 1 (heating) [s]	180
ti2	OFF/0,1...9999	Integral action time 2 (cooling) [s]	180
td1	OFF/0,1...9999	Derivative action time 1 (heating) [s]	180
td2	OFF/0,1...9999	Derivative action time 2 (cooling) [s]	180
t1	0,4...9999	Minimal cycle time 1 (heating) [s]. The minimum impulse is 1/4 x t1	10
t2	0,4...9999	Minimal cycle time 2 (cooling) [s]. The minimum impulse is 1/4 x t2	10
SH	0...9999	Neutral zone or switching differential for on-off control  [phys. dimensions)	2

Parameter-Level

HYS.L	0...9999	Switching difference Low signaller [engineering unit]	1
HYS.H	0...9999	Switching difference High signaller [engineering unit]	1
d.SP	-1999...9999	Trigger point separation for additional contact Δ / Y / Off [phys. dimensions]	100
tP	0,1...9999	Minimum impulse [s]	OFF
tt	3...9999	Motor travel time [s]	60
Y2	-100...100	2. correcting variable	0
Y.Lo	-105...105	Lower output limit [%]	0
Y.Hi	-105...105	Upper output limit [%]	100
Y.0	-100...100	Working point for the correcting variable [%]	0
Ym.H	-100...100	Limitation of the mean value Ym [%] (see Fail page 28)	5
L.Ym	0...9999	Max. deviation xw at the start of mean value calculation □[phys. dimensions]	8
E.H20	-1999...9999	Min. temperature for water cooling. Below the set temperature no water cooling happens.	120
t.on	0,1...9999	Impulse length for water cooling. Fixed for all values of controller output. The pause time is varied.	0,1
t.off	1...9999	Min. pause time for water cooling. The max. effective controller output results from $t.on/(t.on+t.off)-100\%$	2
F.H20	0,1...9999	Modification of the (non-linear) water cooling characteristic □(see page 44)	0,5

❶ Valid for **ConF/othr/DP = 0**. With **DP = 1/2/3** also 0,1 / 0,01 / 0,001.

PAR. 2

Name	Value range	Description	Default
Pb12	1...9999 ❶	Proportional band 1 (heating) in phys. dimensions (e.g. °C), 2. parameter set	100
Pb22	1...9999 ❶	Proportional band 2 (cooling) in phys. Dimensions (e.g. °C), 2. parameter set	100
Ti12	OFF/0,1...9999	Integral action time 2 (cooling) [s], 2. parameter set	180
Ti22	OFF/0,1...9999	Integral action time 1 (heating) [s], 2. parameter set	180
Td12	OFF/0,1...9999	Derivative action time 1 (heating) [s], 2. parameter set	180
Td22	OFF/0,1...9999	Derivative action time 2 (cooling) [s], 2. parameter set	180

SEtP

Name	Value range	Description	Default
SP.Lo	-1999...9999	Set-point limit low for Weff	0
SP.Hi	-1999...9999	Set-point limit high for Weff	900
SP.2	-1999...9999	Set-point 2	0
r.SP	OFF/0,01...9999	Set-point gradient [/min]	OFF
SP.bo	-1999...9999	Boost set-point (see page 72)	30
t.bo	0...9999	Boost time (see page 72)	10
Y.St	-120...120	Start-up correcting value (see page 71)	20
SP.St	-1999...9999	Set-point for start-up	95
t.St	0...9999	Start-up hold time (see page 71)	10
SP	-1999...9999	Set-point (only visible with BlueControl!)	0



SP.Lo and **SP.Hi** should be between the limits of **rnGH** and **rnGL**
see configuration → controller page 28

InP.1

Name	Value range	Description	Default
InL.1	-1999...9999	Input value for the lower scaling point	0
OuL.1	-1999...9999	Displayed value for the lower scaling point	0
InH.1	-1999...9999	Input value for the upper scaling point	20
OuH.1	-1999...9999	Displayed value for the lower scaling point	20
t.F1	0,1...100	Filter time constant [s]	0,5

InP.2

Name	Value range	Description	Default
InL.2	-1999...9999	Input value for the lower scaling point	0
OuL.2	-1999...9999	Displayed value for the lower scaling point	0
InH.2	-1999...9999	Input value for the upper scaling point	50
OuH.2	-1999...9999	Displayed value for the upper scaling point	50

Lim

Name	Value range	Description	Default
L.1	-1999...9999	Lower limit 1	-10
H.1	-1999...9999	Upper limit 1	10
HYS.1	0...9999	Hysteresis limit 1	1
dEL.1	0...9999	Alarm delay from limit value 1 [s]	0
L.2	-1999...9999	Lower limit 2	OFF
H.2	-1999...9999	Upper limit 2	OFF
HYS.2	0...9999	Hysteresis limit 2	1
dEL.2	0...9999	Alarm delay from limit value 2 [s]	0
L.3	-1999...9999	Lower limit 3	OFF
H.3	-1999...9999	Upper limit 3	OFF
HYS.3	0...9999	Hysteresis limit 3	1
dEL.3	0...9999	Alarm delay from limit value 3 [s]	0
HC.A	-1999...9999	Heat current limit [A]	50

6. Input scaling

When using current or voltage signals as input variables for **InP.1** or **InP.2**, scaling of input and display values at parameter setting level is required. Specification of the input value for lower and higher scaling point is in the relevant electrical unit (mA/V).

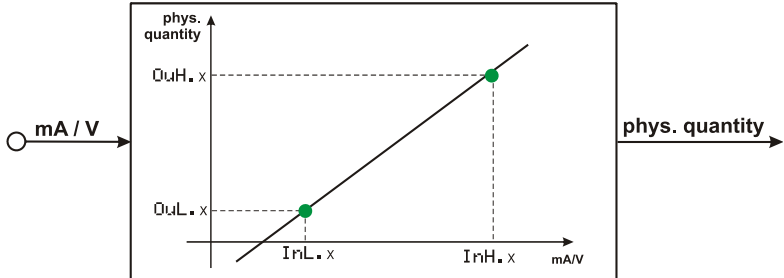

- Input **InP.1**



Parameter **InL.1**, **OuL.1**, **InH.1** und **OuH.1** are only visible if **Conf / InP.1 / Corr = 3** is chosen.

S.tYP	Input signal	InL.1	OuL.1	InH.1	OuH.1
30 (0...20mA)	0 ... 20 mA DC	0	-1999...9999	20	-1999...9999
	4 ... 20 mA DC	4	-1999...9999	20	-1999...9999
40 (0...10V)	0 ... 10 V	0	-1999...9999	10	-1999...9999
	2 ... 10 V	2	-1999...9999	10	-1999...9999

In addition to these settings, **InL.1** and **InH.1** can be adjusted in the range (0...20mA / 0...10V) determined by selection of **S.tYP**.



For using the predetermined scaling with thermocouple and resistance thermometer (Pt100), the settings of **InL.1** and **OuL.1** as well as of **InH.1** and **OuH.1** must correspond.



- Input **InP.2**

S.tYP	Input signal	InL.2	OuL.2	InH.2	OuH.2
30	0 ... 20 mA DC	0	-1999...9999	20	-1999...9999
31	0 ... 50 mA AC	0	-1999...9999	50	-1999...9999

In addition to these settings, **InL.2** and **InH.2** can be adjusted in the range (0...20/ 50mA) determined by selection of **S.tYP**.

7. Calibration level

 Measured value correction (**CAL**) is visible only if **Conf** / **InP. 1** / **Corr = 1** or **2** is selected.



- To access the calibration level, press the key  for 3 seconds and then the key  to select the CAL-Menu item. Press  to confirm.
- If the password function is activated, a prompt for the **PASS** is displayed.





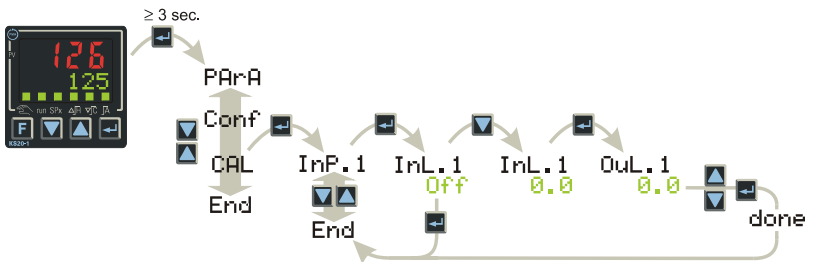

In the calibration menu (**CAL**), the measured value can be adapted. Two methods are available :

Offset correction (**Conf** / **InP. 1** / **Corr = 1**) :



InL. 1 : The input value of the scaling point is displayed.
 The operator must wait, until the process is at rest. Subsequently, the operator acknowledges the input value by pressing key .

OuL. 1 : The display value of the scaling point is displayed.
 Before calibration, **OuL. 1** is equal to **InL. 1**.

The operator can correct the display value by pressing keys . Subsequently, he confirms the display value by pressing key .

Offset correction (**ConF/ InP.1 / Corr =1**):

possible on-line at the process

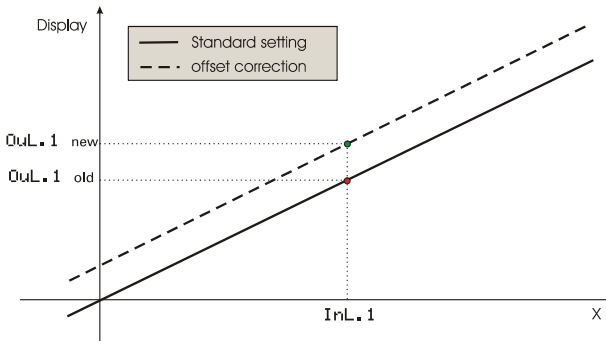



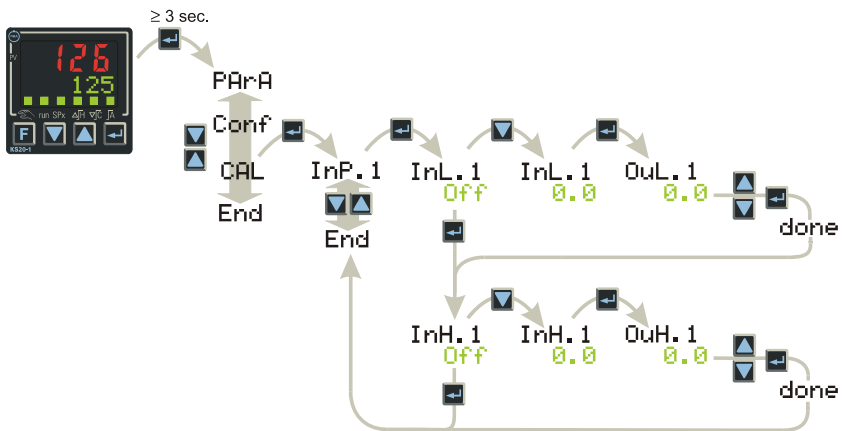

2-point correction (**ConF/ InP.1 / Corr =2**):



InL.1: The input value of the lower scaling point is displayed. The operator must adjust the lower input value by means of a process value simulator and confirm the input value by pressing key \square .

OvL.1: The display value of the lower scaling point is displayed. Before calibration, **OvL.1** is equal to **InL.1**. The operator can correct the lower display value by pressing the \square \triangle keys. Subsequently, he confirms the display value by pressing key \square .

InH. 1: The input value of the upper scaling point is displayed. The operator must adjust the upper input value by means of the process value simulator and confirm the input value by pressing key .

OuH. 1: The display value of the upper scaling point is displayed. Before calibration **OuH. 1** is equal to **InH. 1**. The operator can correct the upper display value by pressing keys . Subsequently, he confirms the display value by pressing key .

2-point correction (ConF/ InP. 1 / Corr = 2):

is possible off-line with process value simulator

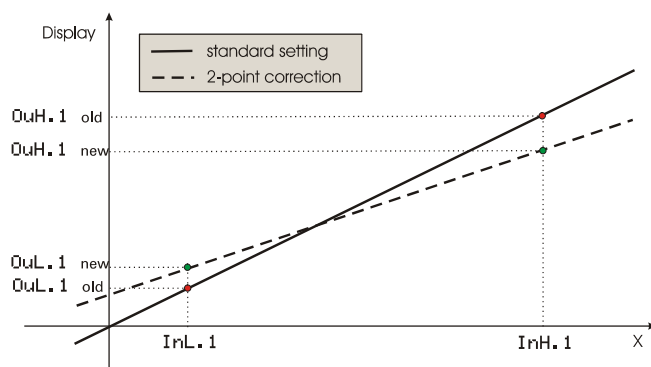

The parameters (**OuL. 1**, **OuH. 1**) altered at **CAL** level can be reset by decreasing them below the lowest adjustment value (**OFF**) using the decrement key .

8. Programmer

8.1 Operation

Programmer operation (run/stop, preset and reset) is via **F**-Key-Menu, digital inputs or interface (BlueControl, superordinate visualization, ...).

- **Operating via front keys**

The function key **F** opens the function menu of the programmer. By using the arrow buttons select a function. In order to exit the screen, either press the **F** key, or it will automatically exit after 30 seconds.



- **Operation via digital inputs**

Functions start/stop and reset can be activated also via digital inputs. For this, parameters **P. run** and **P. off** must be set for digital inputs at **CONF** level **LOGi**.

- **Program/segment selection**

Prerequisite: Programmer is in the reset or stop condition and program / segment selection (**Pr. no / Pr. SG**) is set in the extended operating level.

How to select a defined program (**Pr. no**) followed by a segment (**Pr. SG**) is shown below. When starting the programmer now, program operation starts at the beginning of the selected segment in the selected program.

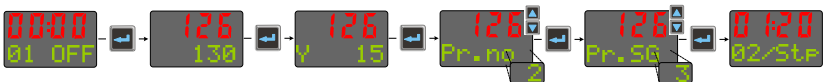

- **Preset**

The preset function is activated via segment selection.

To permit preset in a running program, switch the programmer to stop, select the target segment as described in the above section and switch the programmer to run.

8.1.1 Programmer display



Programmer is in reset and the internal controller set-point is effective. Segment or program number and **OFF** are displayed (configurable with BlueControl: Configuration → Other → PDis3).



Programmer running (run LED is lit). Segment or program number, segment type (↗ rising; ↘ falling; – hold) and program/segment rest time or runtime are displayed (configurable with BlueControl: Configuration → Other → PDis3).



Program end was reached. The set-point defined in the last segment is effective. Segment or program number and **End** are displayed (configurable with BlueControl: Configuration → Other → PDis3).



Function key [E] was used to switch over to the controller. The instantaneously effective correcting variable is displayed.

8.1.2 Segment type

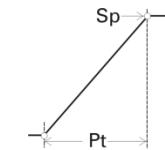
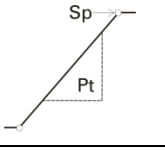
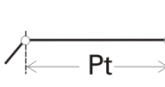
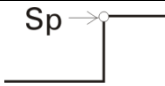
Ramp-segment (time)		With a ramp segment (time), the set-point runs linearly from the start value (end of previous segment) towards the target set-point (Sp) of the relevant segment during time Pt (segment duration).
Ramp-segment (gradient)		With a ramp segment (gradient), the set-point runs linearly from the start value (end value of previous segment) towards the target value (Sp) of the relevant segment. The gradient is determined by parameter Pt.
Hold segment		With a hold segment, the end set-point of the previous segment is output constantly during a defined time which is determined by parameter Pt.
Step segment		With a step segment, the program set-point goes directly to the value specified in parameter Sp. With configured control deviation alarms, the alarm is suppressed within band monitoring.

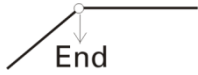
<p>End segment</p>		<p>The last segment in a program is the end segment. When reaching the end segment, output of the setpoint output last is continued.</p>
--------------------	---	--

- **Waiting and operator call**

All segment types except end segment can be combined with "Wait at the end and operator call".

If a segment with combination "wait" was configured, the programmer goes to stop mode at the segment end (run LED is off). Now, the programmer can be restarted by pressing the start/stop key (>3s), via interface or digital input.

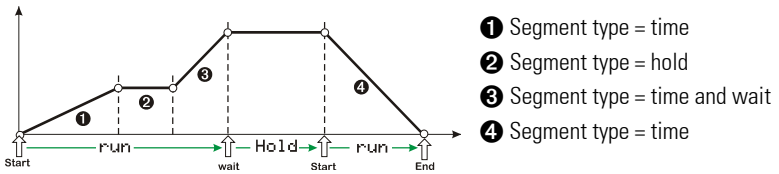

8.1.3 Bandwidth monitoring

Bandwidth monitoring is valid for all program segments. An individual bandwidth can be determined for each program. When leaving the bandwidth (**b.Lo** = low limit; **b.Hi** = high limit), the programmer is stopped (run LED flashes). The program continues running when the process value is within the predefined bandwidth again.

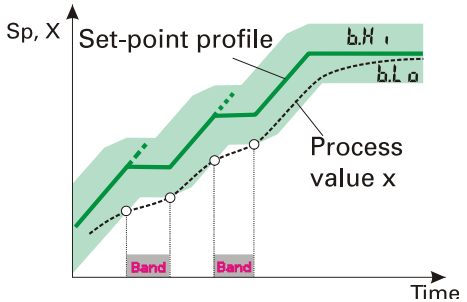

With segment type Step and bandwidth monitoring activated, the control deviation alarm is suppressed, until the process value is in the band again. If band alarm signalling as a relay output is required, a control deviation alarm with the same limits as the band limits must be configured.

8.1.4 Search run at programmer start

The programmer starts the first segment at the actual process value (search run). This may change the effective runtime of the first segment.

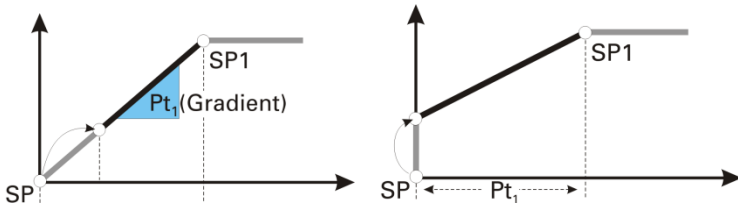

8.1.5 Behaviour after mains recovery or sensor error

Mains recovery

After power recovery, the last program set-points and the time elapsed so far are not available any more. Therefore, the programmer is reset in this case. The controller uses the internal set-points and waits for further control commands (the run LED blinks).



Sensor error

With a sensor error, the programmer goes to stop condition (the run LED blinks). After removal of the sensor error, the programmer continues running.

8.2 Parameter overview

Prog Programmer level			
	Edit Editing programs	COPY Copying programs	End
	PRG	src	
	b.lo	dst	
	b.hi		
	d.00		
	type		
	SP		
	Pt		
	d.out		
	...		
	type		
	SP		
	Pt		
	tout		

Setting:

- The parameters can be set by means of keys  
- Transition to the next parameter is by pressing key 
- After the last parameter of a group, **done** is displayed and an automatic transition the next group occurs



Return to the start of a group is by pressing key  during 3 sec. .

Unless a key is pressed during 30 sec. , the controller returns to process value-set-point display (Time out = 30 sec.)

8.3 Parameter

ProG

Name	Value Range	Description	Default
b.Lo	0...9999	Bandwidth lower limit	-32000
b.Hi	0...9999	Bandwidth upper limit	-32000
d.00		Resetvalue of control track 1 ... 4	0
	0	track 1= 0; track 2= 0; track 3= 0; track 4= 0	
	1	track 1= 1; track 2= 0; track 3= 0; track 4= 0	
	2	track 1= 0; track 2= 1; track 3= 0; track 4= 0	
	3	track 1= 1; track 2=1; track 3= 0; track 4=0	
	4	track 1= 0; track 2= 0; track 3= 1; track 4= 0	
	5	track 1= 1; track 2= 0; track 3= 1; track 4= 0	
	6	track 1= 0; track 2= 1; track 3= 1; track 4= 0	
	7	track 1= 1; track 2= 1; track 3= 1; track 4= 0	
	8	track 1= 0; track 2= 0; track 3= 0; track 4= 1	
	9	track 1= 1; track 2= 0; track 3= 0; track 4=1	
	10	track 1= 0; track 2= 1; track 3= 0; track 4= 1	
	11	track 1= 1; track 2= 1; track 3= 0; track 4= 1	
	12	track 1= 0; track 2= 0; track 3= 1; track 4= 1	
	13	track 1= 1; track 2= 0; track 3= 1; track 4= 1	
	14	track 1= 0; track 2= 1; track 3= 1; track 4= 1	
15	track 1= 1; track 2= 1; track 3= 1; track 4= 1		
tYPE		segment type 1	0
	0	time	
	1	gradient	
	2	hold	
	3	step	
	4	time and wait	
	5	gradient and wait	
	6	hold and wait	
	7	step and wait	
8	end segment		
SP	-1999...9999	segment end set-point 1	
Pt	0...9999	segment time/-gradient 1	
d.Out		control track 1...4 - 1 (see parameter d.00)	
tYPE		segment type 2 (see segment type 1)	0

Name	Value Range	Description	Default
SP	-1999...9999	segment end set-point 2	
Pt	0...9999	segment time/-gradient 2	
d.Out		control track 1...4 - 2 (see parameter d.00)	
tYPE		segment type 3 (see segment type 1)	0
SP	-1999...9999	segment end set-point 3	
Pt	0...9999	segment time/-gradient 3	
d.Out		control track 1...4 - 3 (see parameter d.00)	
tYPE		segment type 4 (see segment type 1)	0
SP	-1999...9999	segment end set-point 4	
Pt	0...9999	segment time/-gradient 4	
d.Out		control track 1...4 - 4 (see parameter d.00)	
tYPE		segment type 3 (see segment type 1)	0
SP	-1999...9999	segment end set-point 5	
Pt	0...9999	segment time/-gradient 5	
d.Out		control track 1...4 - 5 (see parameter d.00)	
tYPE		segment type 6 (see segment type 1)	0
SP	-1999...9999	segment end set-point 6	
Pt	0...9999	segment time/-gradient 6	
d.Out		control track 1...4 - 6 (see parameter d.00)	
tYPE		segment type 7 (see segment type 1)	0
SP	-1999...9999	segment end set-point 7	
Pt	0...9999	segment time/-gradient 7	
d.Out		control track 1...4 - 7 (see parameter d.00)	
tYPE		segment type 8 (see segment type 1)	0
SP	-1999...9999	segment end set-point 8	
Pt	0...9999	segment time/-gradient 8	
d.Out		control track 1...4 - 8 (see parameter d.00)	
• • •	• • •	• • •	• • •
tYPE		segment type 15 (see segment type 1)	0
Pt	0...9999	segment time/-gradient 15	
d.Out		control track 1...4 - 15 (see parameter d.00)	
tYPE		segment type 16 (see segment type 1)	0
SP	-1999...9999	segment end set-point 16	
Pt	0...9999	segment time/-gradient 16	
d.Out		control track 1...4 - 16 (see parameter d.00)	

8.4 Programmer description

8.4.1 General

An overview of the most important features:

- Programs: 16
- Control outputs: 4
- Segments: 16 per program
- Segment types:
 - ramp (set-point and time)
 - ramp (set-point and gradient)
 - hold segment (holding time)
 - step segment (with alarm suppression)
 - end segment

All segment types can be combined with "Wait at the end and call operator"

- Time unit: configurable in hours:minutes or minutes:seconds
- Maximum segment duration: 9999 hours = 1 year 51 days
- Maximum program duration: 16 x 9999 hours = > 18 years
- Gradient: 0,01°C/h (/min) to 9999°C/h (/min)
- Program name: 8 characters, adjustable via BlueControl software
- Bandwidth control: bandwidth high and low (**b.Lo**, **b.Hi**) limits definable for each program

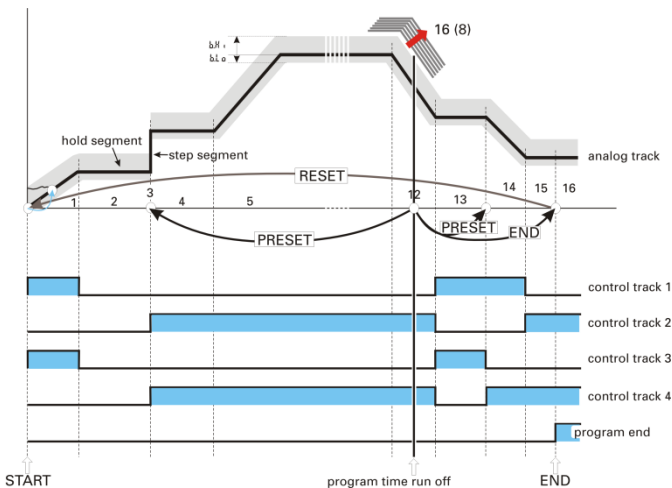

8.4.2 Programmer set-up:

The instrument is factory-configured as a program controller. The following settings must be checked:

- Set-point function**
 For using the controller as a programmer, select parameter **SP.Fn = 1 / 9** in the **ConF** menu (→ page 27).
- Time base**
 The time base can be set to hours:minutes or minutes:seconds in the **ConF** menu; parameter **t.bAS** (→ page 29).
- Digital signals**
 For assigning a control output, program end or the operator call as a digital signal to one of the outputs, set parameter **P.End, PrG1 ... PrG4** or **CALL** to 1 for the relevant output **OUT. 1 ...OUT. 6** in menu **ConF** (→ page 31 ff).
- Programmer operation**
 The programmer can be started, stopped and reset via one of the digital inputs di1..4. Which input should be used for each function is determined by selecting parameters **P.run** and **P.off = 2 - 5** or **7 -9** in the **ConF** menu **Losi** accordingly (→ page 35).

Further settings, which affect the programmer display layout and operation are only possible using the BlueControl software (see picture below)

Name	Description	Value	on	Range
othr	Other			
pTmp	access temporary program changes	0: enabled		
pPre	access preset to end and reset	0: enabled		
pRun	access run / stop	0: enabled		
pSwi	access switch controller	0: enabled		
pCom	access common program paramet...	0: enabled		
pEdi	access editation level	0: enabled		
lPrg	access programmer level	0: enabled		
PDis3	display 3 programmer operation	0: segment no., segment type, remaining prog time		

Outout from the BlueControl® Configuration "othr"

Programmer parameter setting

16 programmers with 16 segments each are available to the user. The relevant parameters must be determined in menu **ProG** . (→ page 66).

The procedure for editing a program is shown below.



Select the program you want to edit by means of keys **▼▲** and confirm it with **↵**.

Start by setting the bandwidth high and low (**b.Lo**; **b.Hi**) limits and the control output reset value (**d.00**) for the selected program. The bandwidth is valid for all.



Configuration parameter **FCom** (→ page 40) can be used for display suppression of bandwidth parameters and control output reset value, which, however, remains valid.

Select the segment number (**SEG**; Segm.-No) for the segment which is to be edited.

Now, enter segment type, segment end set-point, segment time/gradient and control output.

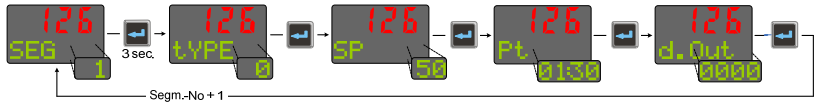



After confirming parameter **d.Out** with key , select the following segment.

Copying a program

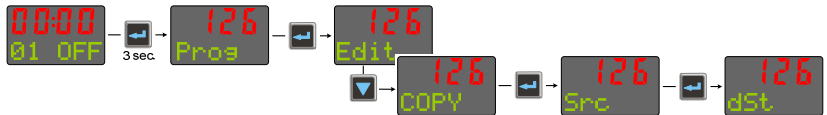
The procedure for copying a program is shown below.



When confirming function **COPY** with key , the program which shall be copied must be selected (**Src**). Subsequently, the target program (**dSt**) must be adjusted. Press key  to start copying.

9. Special functions

9.1 Start-up circuit

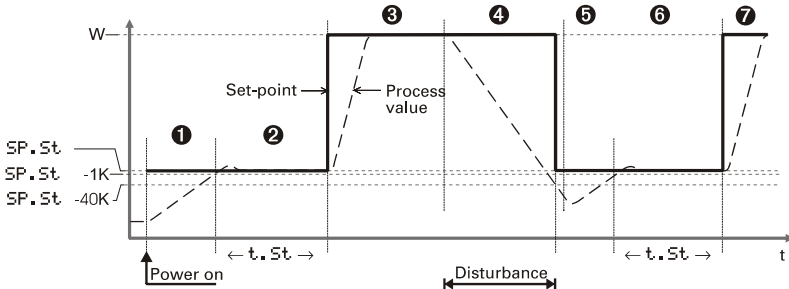

The start-up circuit is a special function for temperature control, e.g. hot runner control. High-performance heating cartridges with magnesium oxide insulation material must be heated slowly to remove moisture and prevent destruction.

Operating principle:

- ❶ After switching on the supply voltage, stabilised to the start-up set-point $SP.St$ is using a maximum start-up correcting value of $Y.St$.
 - ❷ The start-up holding time $t.St$ is started one K below the start-up set-point ($SP.St - 1K$).
 - ❸ Subsequently, the process is lined out to set-point W .
 - ❹ If the process value drops by more than 40 K below the start-up set-point ($SP.St - 40K$) due to a disturbance, the start-up procedure is re-started (❺, ❻, ❼).
- ⓘ With $W < SP.St$, W is used as set-point. The start-up holding time $t.St$ is omitted.
- ⓘ If the gradient function ($PARA/SETP/r.SP \neq OFF$) was selected, start-up value $SP.St$ is reached with the adjusted gradient $r.SP$.
- ⓘ With the boost function (see chapter 9.2 page 72) selected, W is increased by $SP.bo$ during time $t.bo$.

The following settings can be selected:

- $SP.Fn = 10$ set-point + start-up circuit
 The start-up circuit is effective only with the internal set-point.
- $SP.Fn = 11$ set-point, $SP.E/SP.2$ + start-up circuit
 The start-up circuit is effective also with the external set-point $SP.E$ and the 2nd set-point $SP.2$.

9.2 Boost function

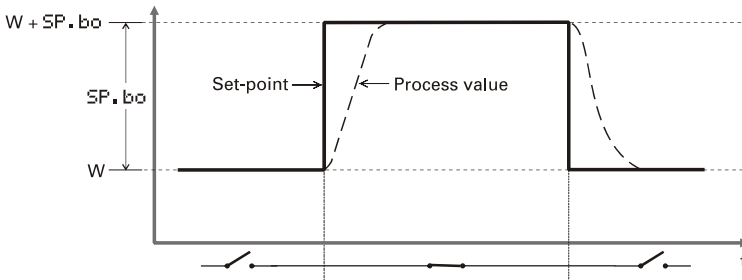

The boost function causes temporary increase of the set-point, e.g. for removing "frozen" material from clogged die nozzles with hot-runner control.

If configured (**rCONF/LOGI/booS**), the boost function can be started via digital input di1/2/3, with the function key on the instrument front panel or via the interface (OPTION).

The set-point increase around boost set-point **PARA/SEtP/SP.bo** remains effective as long as digital signal (di1/2/3, function key, interface) remains set. The maximum permissible cycle time (boost time-out) is determined by parameter **PARA/SEtP/t.bo**.

Unless reset after elapse of boost time **t.bo**, the boost function is finished by the controller.



The boost function also works with:

- start-up circuit: **PARA/SEtP/SP.bo** is added to W after elapse of start-up holding time **PARA/SEtP/ t.St**.
- Gradient function: set-point W is increased by **PARA/SEtP/ SP.bo** with gradient **PARA/SEtP/ r.SP**.

9.3 KS 20-1 as Modbus-Master



This function is only selectable with the BlueControl engineering tool

Additions **othr** (only visible with BlueControl!)

Name	Value range	Description	Default
MASt		Controller is used as Modbus master	0
	0	Slave	
	1	Master	
Cycl	0...200	Cycle time [ms] for the Modbus master to transmit its data to the bus.	60
AdrO	1...65535	Target address to which the with AdrU specified data is given out on the bus.	1
AdrU	1...65535	Modbus address of the data that Modbus master gives to the bus.	1
Numb	0...100	Number of data that should be transmitted by the Modbus master.	0

The controller can be used as Modbus master (**ConF** / **othr** / **MASt** = **1**).

The Modbus master sends its data to all slaves (broadcast message, controller adress 0). It transmits its data (modbus adress **AdrU**) cyclic with the cycle time **Cycl** to the bus. The slave controller receives the data transmitted by the master and allocates it to the modbus target address **AdrO**.

If more than one data should be transmitted by the master controller (**Numb** > **1**), the modbus address **AdrU** indicates the start address of the data that should be transmitted and **AdrO** indicates the first target address where the received data should be stored. The following data will be stored at the next available modbus address.

With this it is possible e.g. to specify the process value of the master controller as set-point for the slave controllers.

9.4 Linearization

- Linearization for input INP1

The "Lin" parameter is valid if the following condition is met:

S.tYP	and	S.Lin
= 18 (Special linearization)		----
= 23 (KTY11-6)		----
= 30 (Current)		= 1: Special linearization
= 40 (Voltage)		= 1: Special linearization

Dependent of input type, the input signals are specified in μV , Ω , mA or Volt dependent of input type.

With up to 16 segment points, non-linear signals can be simulated or linearized. Every segment point comprises an input (**In. 1 ... In. 16**) and an output (**Ou. 1 ... Ou. 16**). These segment points are interconnected automatically by means of straight lines.

The straight line between the first two segments is extended downwards and the straight line between the two largest segments is extended upwards.

I.e. a defined output value is also provided for each input value. When switching an **In.x** value to **OFF**, all other ones are switched off. Condition for these configuration parameters is an ascending order.

In. 1 < In. 2 < ... < In. 16 und Ou. 1 < Ou. 2 ... < Ou. 16.

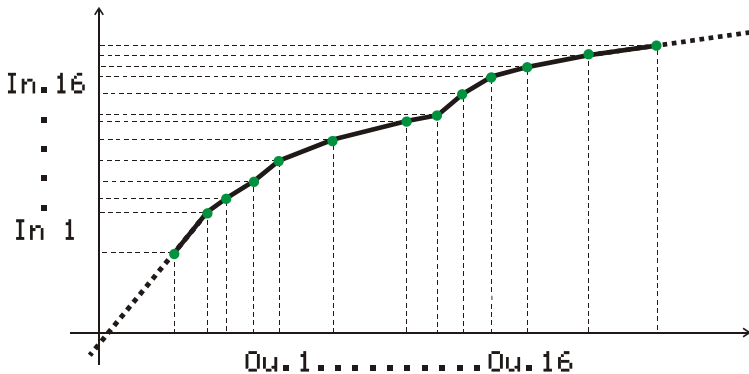

9.5 Timer

9.5.1 Setting up the timer

- **Operating modes**

6 different timer modes are available to the user. The relevant timer mode can be set via parameter SP.Fn in the Conf menu (→ page 27).

Mode 1 (—)

After timer start, control is to the adjusted set-point . The timer ($t_{.SP}$) runs as soon as the process value enters or leaves the band around the set-point ($x = SP \pm b_{.ti}$). After timer elapse, the controller returns to **Y2**. **End** and the set-point are displayed alternately in the lower display line.

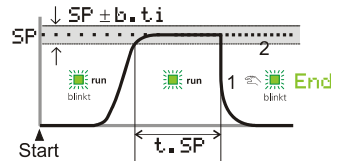

Mode 2 (....)

Mode 2 corresponds to mode 1, except that control is continued with the relevant set-point after timer ($t_{.SP}$) elapse.

Mode 3 (—)

After timer start, control is to the adjusted set-point. The timer ($t_{.SP}$) starts immediately after switch-over. After timer elapsing the controller switches off. **End** and the set-point are displayed alternately in the bottom display line.

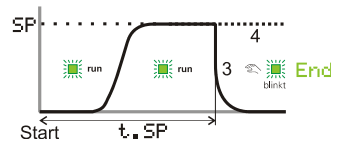

Mode 4 (....)

Mode 4 corresponds to mode 3, except that control is continued with the relevant set-point after timer ($t_{.SP}$) elapse.

Mode 5 (delay)

The timer starts immediately. The controller output remains on Y2. After timer ($t_{.SP}$) elapse, control starts with the adjusted set-point.

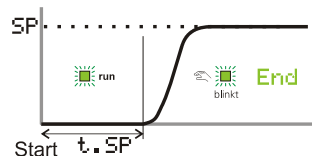

Mode 6

After set-point switch-over ($SP \rightarrow SP_{.2}$), control is to $SP_{.2}$. The timer ($t_{.SP}$) starts when the process value enters the adjusted band around the set-point ($x = SP_{.2} \pm b_{.ti}$).

After time elapse the controller returns to SP . **End** and the set-point are displayed alternately in the lower display line.

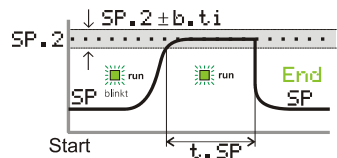

- **Tolerance band**

Timer modes 1,2 and 6 are provided with a freely adjustable tolerance band. The tolerance band around the set-point can be adjusted via parameter **b.ti** in the **Conf** menu ($x = SP.2 \pm b.ti$) (→ page 27).

- **Timer start**

Various procedures for starting the timer are possible:

Start via		LOGI		Mode					
		Y2 =	SP.2 =	1	2	3	4	5	6
Y / Y2 – switch-over via digital input ^❶	di1	2	x	✓	✓	✓	✓	✓	✓
	di2	3	x	✓	✓	✓	✓	✓	✓
	di3	4	x	✓	✓	✓	✓	✓	✓
	di4	5	x	✓	✓	✓	✓	✓	✓
SP / SP.2 - switch-over via digital input ^❶	di1	x	2	•	•	•	•	•	✓
	di2	x	3	•	•	•	•	•	✓
	di3	x	4	•	•	•	•	•	✓
	di4	x	5	•	•	•	•	•	✓
Pressing key F and select Y		6	x	✓	✓	✓	✓	✓	•
Power on		0	x	✓	✓	✓	✓	✓	•
		x	0	•	•	•	•	•	✓
Changing t.ti (extending operation level)		x	x	✓	✓	✓	✓	✓	✓
Serial interface (if provided)		x	x	✓	✓	✓	✓	✓	✓

❶ when using a digital input, adjust parameter di.Fn = 2 (ConF/ LOGI) (key function)
 x no effect

- **Signal end**

If one of the relays activates after the timer has elapsed, parameter **TIME** = 1 and inverse action **O.Act** = 1 must be selected for the relevant output **OUT.1** ... **OUT.3** in the **Conf** menu (→ page 32). If direct action is selected, the relevant output signals the active timer.

9.5.2 Determining the timer run-time

The timer run-time can be determined via parameter **t.SP** in the **PARA** menu. The timer run-time must be specified in minutes with one digit behind the decimal point (0,1 minutes = 6 seconds).

Alternatively, the timer run-time can be determined directly at extended operating level (→ chapter 9.5.3).

9.5.3 Starting the timer

Dependent of configuration, the timer start is as follows:

- by a positive activation at one of digital inputs di1..3
- by switching on the manual mode via **[F]** - key
- by switching on the controller (power On)
- by changing the timer run-time **t.t.i** > 0 (extended operating level)
- via the serial interface

- Display:

run-LED	Signification
<i>blinks</i>	<ul style="list-style-type: none"> • timer was started • timer is not running yet
<i>lit</i>	<ul style="list-style-type: none"> • timer was started • timer is running
<i>off</i> (End and setpoint are displayed alternately)	<ul style="list-style-type: none"> • timer is off • timer has elapsed • deletion of End display by pressing any key



With active timer, the time can be adjusted by changing parameter t.t.i at extended operating level.

11. BlueControl®

BlueControl is the projection environment for the BluePort® controller series of PMA. The following 3 versions with graded functionality are available:

FUNCTIONALITY	MINI	BASIC	EXPERT
parameter and configuration setting	yes	yes	Yes
controller and loop simulation	yes	yes	yes
download: transfer of an engineering tot he controller	yes	yes	yes
online mode / visualization	SIM only	yes	yes
defining an application specific linearization	yes	yes	yes
configuration in the extended operation level	yes	yes	yes
upload: reading an engineering from the controller	SIM only	yes	yes
basic diagnostic function	no	no	yes
saving data file and engineering	no	yes	yes
printer function	no	yes	yes
online documentation, help	yes	yes	yes
implementation of measurement value correction	yes	yes	yes
data acquisition and trend display	SIM only	yes	yes
wizard function	yes	yes	yes
extended simulation	no	no	yes
programmeditor	no	no	yes

The mini version of BlueControl is available to download- free of charge - at www.west-cs.com. At the end of the installation the licence number has to be stated or DEMO mode must be chosen. At DEMO mode the licence number can be stated subsequently under **Help → Licence → Change**.

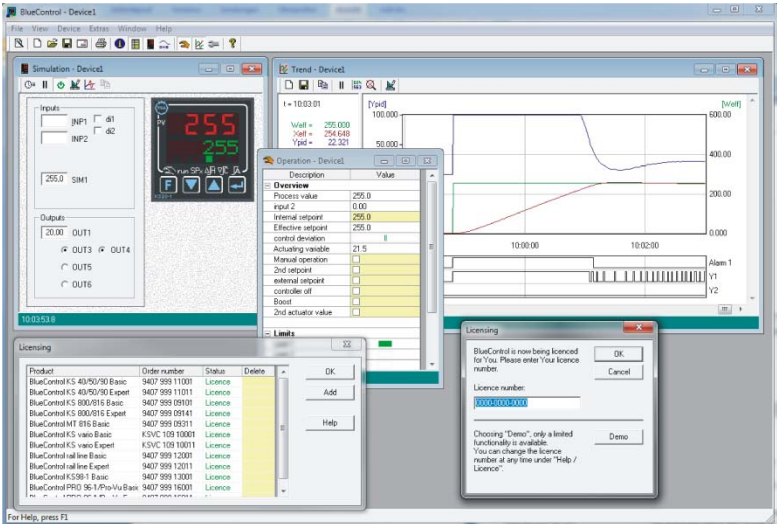

11.1 Configuration Port

The BluePort® interface is used to connect to the PC based BlueControl® configuration tool.

The PC is connected via a mini USB adapter to the device. The connector is located on top of the housing (see picture)



This is not a USB interface.
Only the connector has the
shape of a mini-USB connector!



12. Technical Data

INPUTS

Process value input INP1

Resolution:	> 14 Bit (20.000 steps)
Decimal point:	0 to 3 digits behind the decimal point
Dig. input filter:	adjustable 0,0...100,0 s
Scanning cycle:	100 ms
Measured value correction:	2-point or offset correction

Thermocouples →Table 1 (page 83)

Input resistance:	≥1 MΩ
Effect of source resistance:	1 μV/Ω

Cold-junction compensation: intern
max. additional error: <0,5 K

Sensor break monitoring

Sensor current:	≤ 1 μA
-----------------	--------

Configurable output action

Resistance thermometer

→Table 2 (page 83)

Connection:	2- or 3-wire
Lead resistance:	max. 30 Ω
Input circuit monitor:	Break and short circuit

Current and voltage signals

→Table 3 (page 83)

Span start, end of span:	anywhere within measuring range selectable -1999...9999
--------------------------	---

Scaling:	16 segments, adaptable with BlueControl, decimal point: adjustable
input circuit monitor:	12,5% below span start (2mA, 1V)

Accuracy:	Better 0,1%
-----------	-------------

Supplementary input INP2

Heating current measurement via current transformer

Measuring range:	0...30 mA AC
Scaling: adjustable	-1999..0,000..9999
Accuracy:	Better than 0,25%

Current measuring range

Input resistance:	ca. 120 Ω
Span:	anywhere within 0 to 20mA
Scaling:	anywhere -1999...9999

Input circuit monitor: 12,5% below span start (4..20mA → 2mA)

CONTROL INPUT DI1/DI2

Configurable as direct or inverse switch or push-button!

Connection of a potential-free contact suitable for switching "dry" circuits.

Switched voltage:	3.3 V
Switched current:	< 10mA

Control inputs di3 & di4 (option)

Configurable as direct or inverse.

Nominal voltage:	24 V DC, external
Current sink (IEC 1131 Type 1)	

Logic "0":	-3...5 V
Logic "1":	15...30 V

Current requirement: approx. 5 mA

Transmitter supply UT (option)

Power:	22 mA / ≥ 18 V
--------	----------------

OUTPUTS

Output used for:

Relay – option 1-3

Contacts:	Potential free changeover
Max contact rating:	2A@ 250V 48...62Hz
Min contact rating:	6V, 1mA
Duty cycle:	I = 1A/2A 250,000/150,000 @ 250V resistive

Dual relay – option 2

Contacts:	2 NO contacts with shared common
Max contact rating:	2A@ 250V 48...62Hz
Min contact rating:	6V, 1mA
Duty cycle:	I = 1A/2A 500,000/200,000 @ 250V resistive

SSR - option 1-3

Voltage:	10 V into 500 Ω minimum
----------	-------------------------

Dual SSR - option 1-3

Voltage	10 V into 500 Ω minimum
---------	-------------------------

Linear DC output option 1 & 3

Current output

0/4mA...20 mA, configurable.

Signal range: 0...approx. 22 mA

Load: $\leq 500 \Omega$

Load effect: none

Resolution: (0.1%)

Error: (0.2%)

0-10 V

Signal range: 0...11 V

Load: $\geq 2K \Omega$

Resolution: $\leq 0.1 \%$

Error: $\leq 0.2 \%$

Serial Interface

Physical: RS485, at 1200, 2400, 4800, 9600 or 19200 bps.

Protocol: Modbus RTU Communications

RS485 Option 3 or A

Transmitter supply

Output: 22 mA / $\geq 18 V$

Note:

If the relays operate external contactors, these must be fitted with RC snubber circuits to manufacturer specifications to prevent excessive switch-off voltage peaks.

POWER SUPPLY

Depending on version:

AC Supply

Voltage: 90...260 VAC

Frequency: 48...62 Hz

Power consumption approx. 7 VA

Universal supply 24 V UC

AC voltage: 20,4...26,4 VAC

Frequency: 48...62 Hz

DC voltage: 18...31 V DC

Power consumption: approx: 7 VA (W)

Behaviour with power failure

Configuration, parameters and adjusted setpoints, control mode:

Non-volatile storage in EEPROM

ENVIRONMENTAL CONDITIONS

Protection modes

Front panel: IP 65 (NEMA 4X)

Housing: IP 20

Terminals: IP 20

Permissible temperatures

For specified accuracy: 0...60°C

Warm-up time: ≥ 15 minutes

Temperature effect: $< 100\text{ppm/K}$

For storage: -20...70°C

Humidity

75% yearly average, no condensation

Electromagnetic compatibility

Complies with EN 61 326-1 (for continuous, non-attended operation)

General

Housing

Material: Lexan PC940A

Flammability class: UL 94 VO, self-extinguishing

Plug-in module, inserted from the front

Safety tests

Complies with EN 61010-1

Over voltage category II

Contamination class 2

Working voltage range 300 VAC

Protection class II

Certifications

cULus-certification: (Type 1, indoor use)

File: E 208286

Terminals

5mm Combicon

Mounting

Panel mounting with quick release fixing mounting clamp (supplied).

Technical Data

Table 1 Thermocouples measuring ranges

Thermocouple type		Measuring range		Accuracy	Resolution (Ø)
L	Fe-CuNi (DIN)	-100...900°C	-148...1652°F	≤ 2K	0,1 K
J	Fe-CuNi	-100...1200°C	-148...2192°F	≤ 2K	0,1 K
K	NiCr-Ni	-100...1350°C	-148...2462°F	≤ 2K	0,2 K
N	Nicrosil/Nisil	-100...1300°C	-148...2372°F	≤ 2K	0,2 K
S	PtRh-Pt 10%	0...1760°C	32...3200°F	≤ 2K	0,2 K
R	PtRh-Pt 13%	0...1760°C	32...3200°F	≤ 2K	0,2 K
T	Cu-CuNi	-200...400°C	-328...752°F	≤ 2K	0,05 K
C	W5%Re-W26%Re	0...2315°C	32...4199°F	≤ 2K	0,4 K
D	W3%Re-W25%Re	0...2315°C	32...4199°F	≤ 2K	0,4 K
E	NiCr-CuNi	-100...1000°C	-148...1832°F	≤ 2K	0,1 K
B *	PtRh-Pt6%	0(100)...1820°C	32(212)...3308°F	≤ 2K	0,3 K

* Specifications valid for 100°C

Table 2 Resistance transducer measuring ranges

Type	Measuring current	Measuring range		Accuracy	Resolution (Ø)
Pt100	0,2mA	-200...100°C	-140...212°F	≤ 1K	0,1K
Pt100		-200...850°C	-140...1562°F	≤ 1K	0,1K
Pt1000		-200...200°C	-140...392°F	≤ 2K	0,1K
KTY 11-6 *		-50...150°C	-58...302°F	≤ 2K	0,05K
Special		0...4500		≤ 0,1 %	0,01 %
Special		0...450			
Potentiometer		0...160			
Potentiometer		0...450			
Potentiometer		0...1600			

* Or special

Table 3 Current and voltage measuring ranges

Measuring range	Input resistance	Accuracy	Resolution (Ø)
0-10 Volt	≈ 110 kΩ	≤ 0,1 %	0,6 mV
0-20 mA	49 Ω (voltage requirement ≤ 2,5 V)	≤ 0,1 %	1,5 μA

13. Safety notes

This unit was built and tested in compliance with VDE 0411-1 / EN 61010-1 and was delivered in safe condition.

The unit complies with European guideline 89/336/EWG (EMC) and is provided with CE marking.

The unit was tested before delivery and has passed the tests required by the test schedule. To maintain this condition and to ensure safe operation, the user must follow the hints and warnings given in this operating manual.

The unit is intended exclusively for use as a measurement and control instrument in technical installations.



Warning!

If the unit is damaged to an extent that safe operation seems impossible, the unit must not be taken into operation.

ELECTRICAL CONNECTIONS

The electrical wiring must conform to local standards (e.g. VDE 0100). The input measurement and control leads must be kept separate from signal and power supply leads.

COMMISSIONING

Before instrument switch-on, check that the following information is taken into account:

- Ensure that the supply voltage corresponds to the specifications on the type label.
- All covers required for contact protection must be fitted.
- If the controller is connected with other units in the same signal loop, check that the equipment in the output circuit is not affected before switch-on. If necessary, suitable protective measures must be taken.
- The unit may be operated only in installed condition.
- Before and during operation, the temperature restrictions specified for controller operation must be met.

SHUT-DOWN

For taking the unit out of operation, disconnect it from all voltage sources and protect it against accidental operation.

If the controller is connected with other equipment in the same signal loop, check that other equipment in the output circuit is not affected before switch-off. If necessary, suitable protective measures must be taken.

MAINTENANCE, REPAIR AND MODIFICATION

The units do not need particular maintenance.



Warning!

When opening the units, or when removing covers or components, live parts and terminals may be exposed.

Before starting this work, the unit must be disconnected completely.

After completing this work, re-shut the unit and re-fit all covers and components. Check if specifications on the type label must be changed and correct them, if necessary.



Caution!

When opening the units, components which are sensitive to electrostatic discharge (ESD) can be exposed. The following work may be done only at workstations with suitable ESD protection.

Modification, maintenance and repair work may be done only by trained and authorized personnel. For this purpose, the West Control Solutions / PMA service department service should be contacted.



Cleaning

Should cleaning be necessary, the front panel should be cleaned by washing with warm soapy water and drying immediately using a dry, lint free cloth.

13.1 Resetting to factory setting

In case of faulty configuration, KS20-1 can be reset to the default condition.

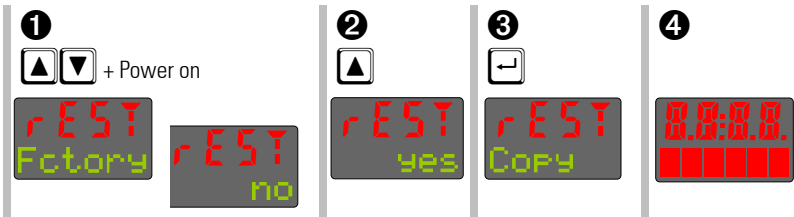

- ❶ For this, the operator must keep the UP and DOWN keys pressed during power-on.
- ❷ Then, press UP key to select YES.
- ❸ Confirm factory resetting with Enter and the copy procedure is started (display COPY).
- ❹ Afterwards the device restarts.

In all other cases, no reset will occur (timeout).

- i** If one of the operating levels was blocked and the safety lock is open, reset to factory setting is not possible.
- i** If a pass number was defined (via BlueControl®) and the safety lock is open, but no operating level was blocked, enter the correct pass number when prompted in 3. A wrong pass number aborts the reset action.
- i** The copy procedure (COPY) can take some seconds. Now, the transmitter is in normal operation.

Austria



**PMA Prozeß- und Maschinen-
Automation GmbH**

Liebermannstraße F01
2345 Brunn am Gebirge
Tel.: +43 (0)2236 691-121
Fax: +43 (0)2236 691-102
Email: info@west-cs.com

Germany



**PMA Prozeß- und Maschinen-
Automation GmbH**

Miramstraße 87
34123 Kassel
Tel.: +49 (0)561 505-1307
Fax: +49 (0)561 505-1710
Email: info@west-cs.com

China



Danaher Setra-ICG

Tianjin Co. Ltd. No. 28 Wei 5 Road
The Micro-Electronic Industry Park TEDA Xiqing
District • Tianjin 300385
Tel.: +86 22 8398 8098 • Sales: +86 400 666 1802
Fax: +86 22 8398 8099
Email: tc.sales@danaher.com

United Kingdom



WEST Control Solutions

The Hyde Business Park
Brighton • East Sussex •
BN2 4JU
Tel.: +44 (0)1273 606271
Fax: +44 (0)1273 609990
Email: info@west-cs.com

France



WEST Control Solutions

France
Tel.: +33 (1) 77 80 90 40
Fax: +33 (1) 77 80 90 50
Email: info@west-cs.com

United States



WEST Control Solutions

1675 Delany Road
Gurnee • IL 60031-1282
Tel.: 800 866 6659
Fax: 847 782 5223
Email: custserv.west@dancon.com